

1 door jamb detail
3"x11'-0"

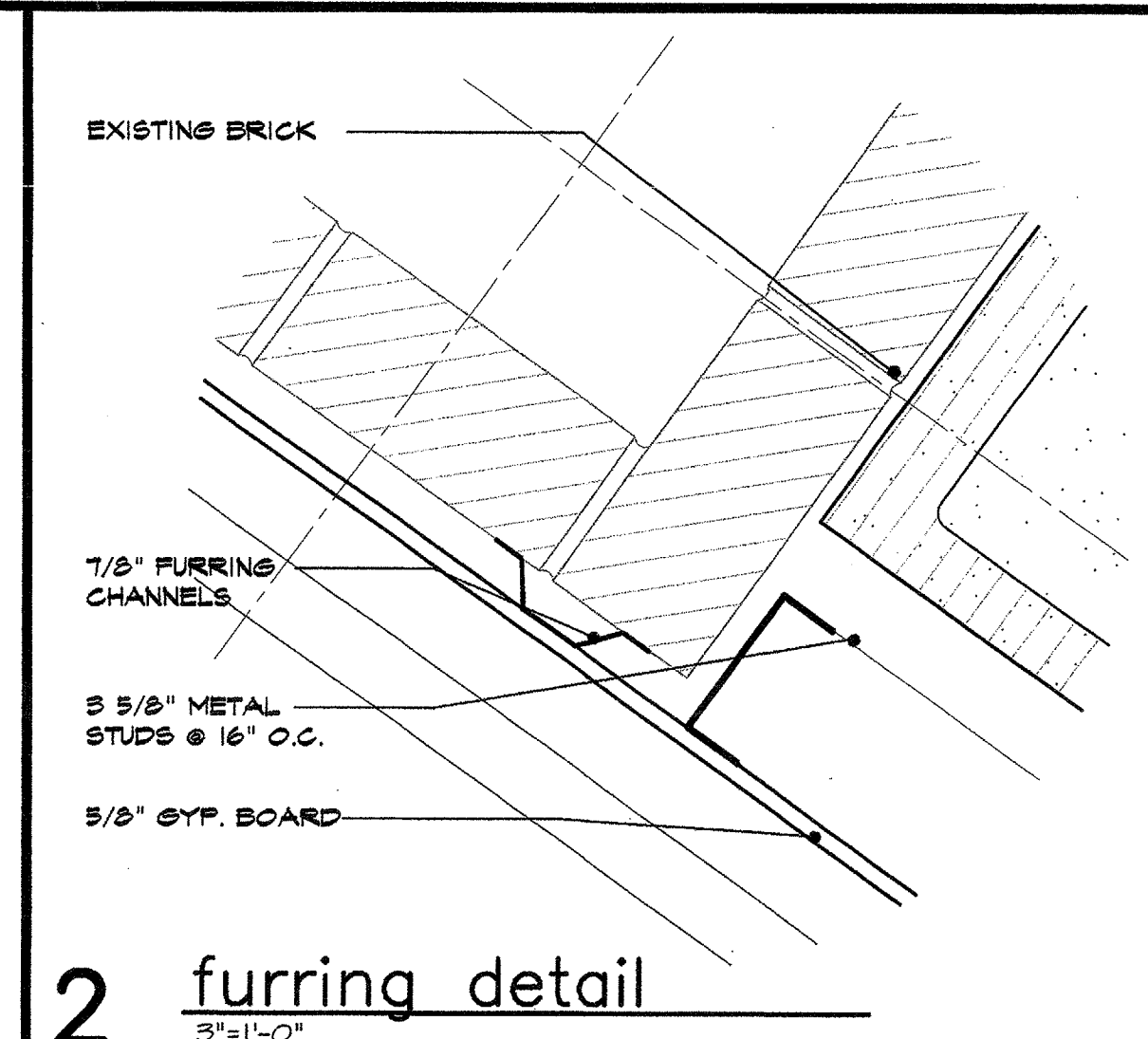

2 furring detail
3"x11'-0"

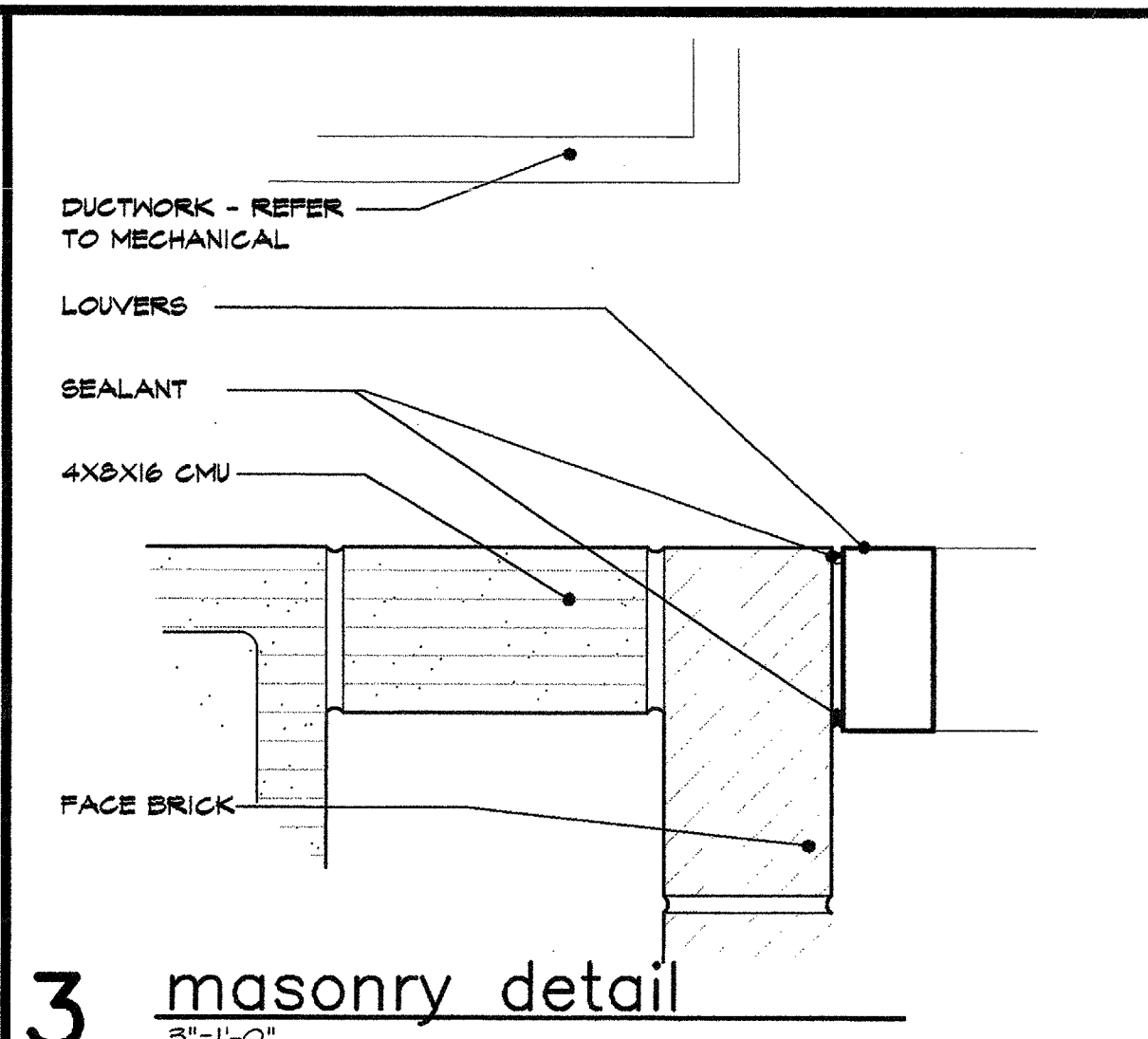

3 masonry detail
3"x11'-0"

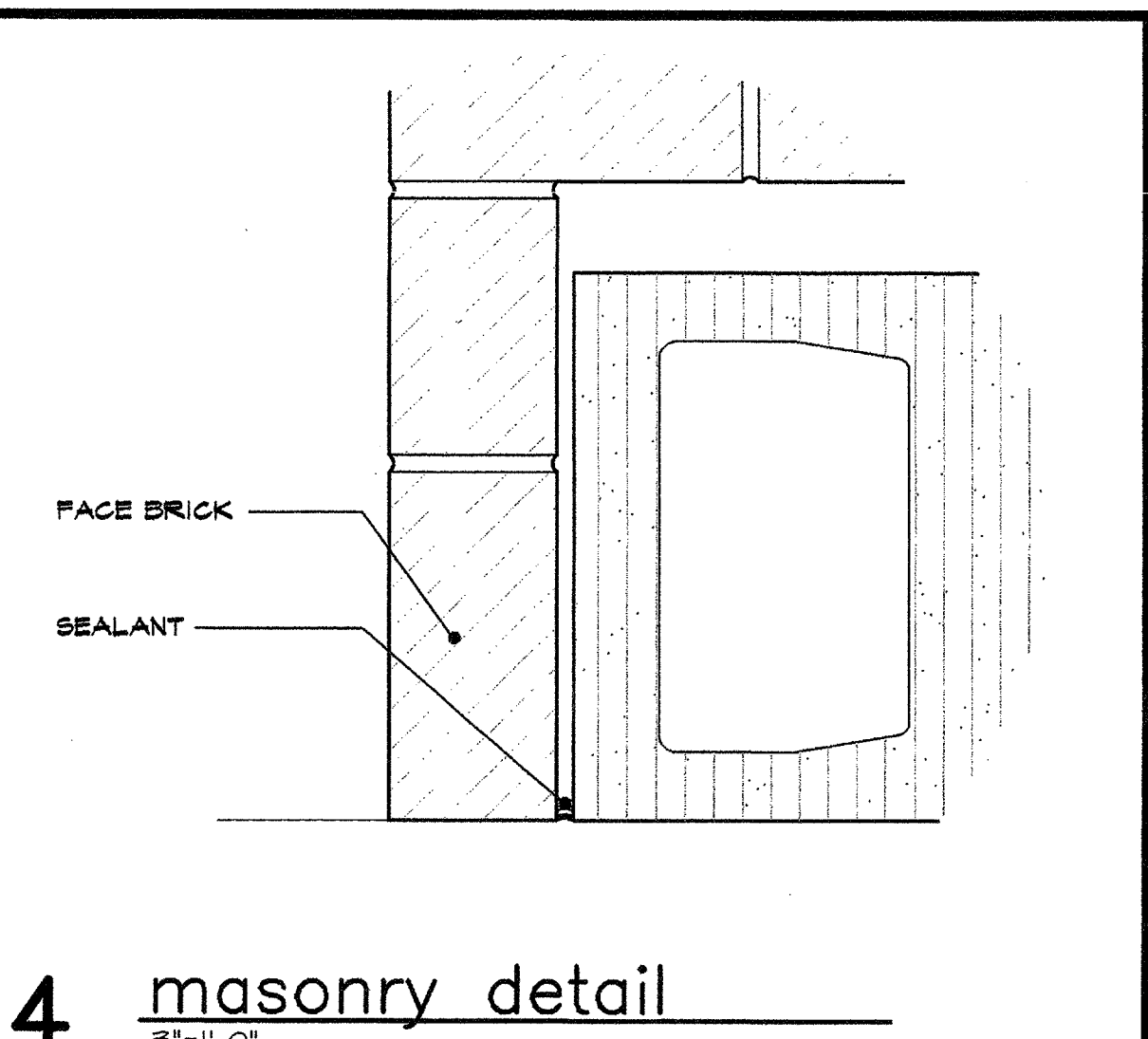

4 masonry detail
3"x11'-0"

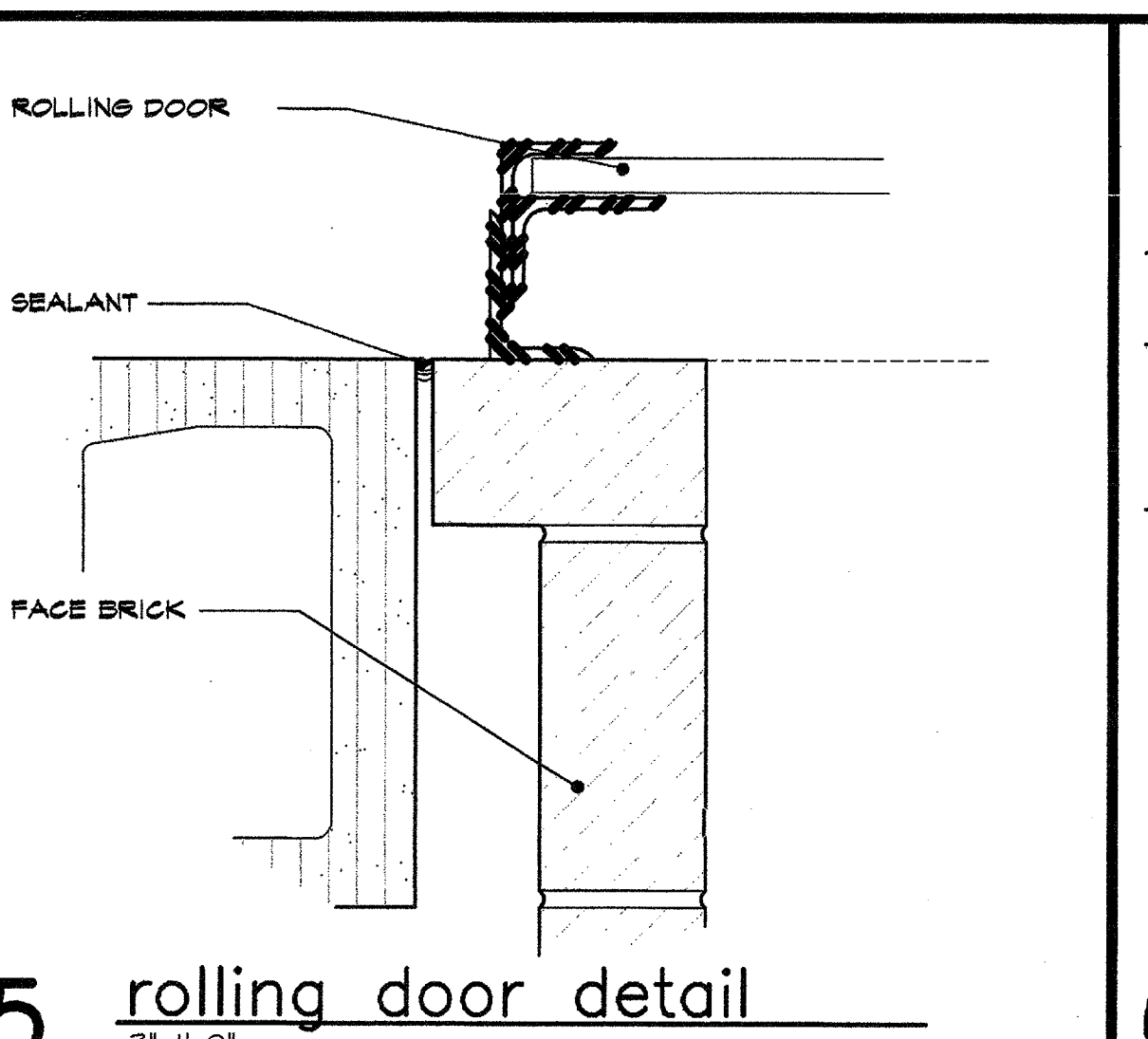

5 rolling door detail
3"x11'-0"

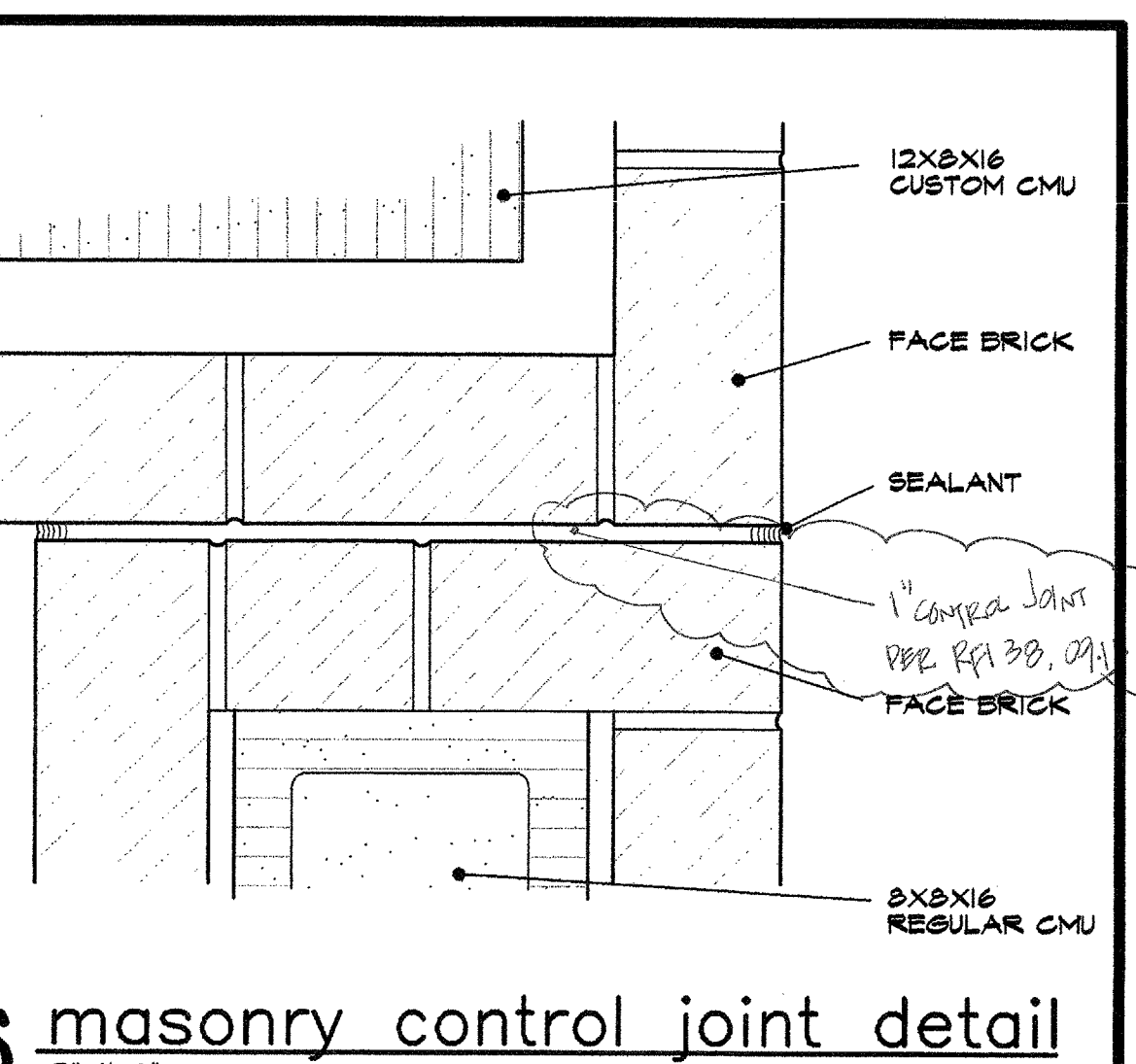

6 masonry control joint detail
3"x11'-0"

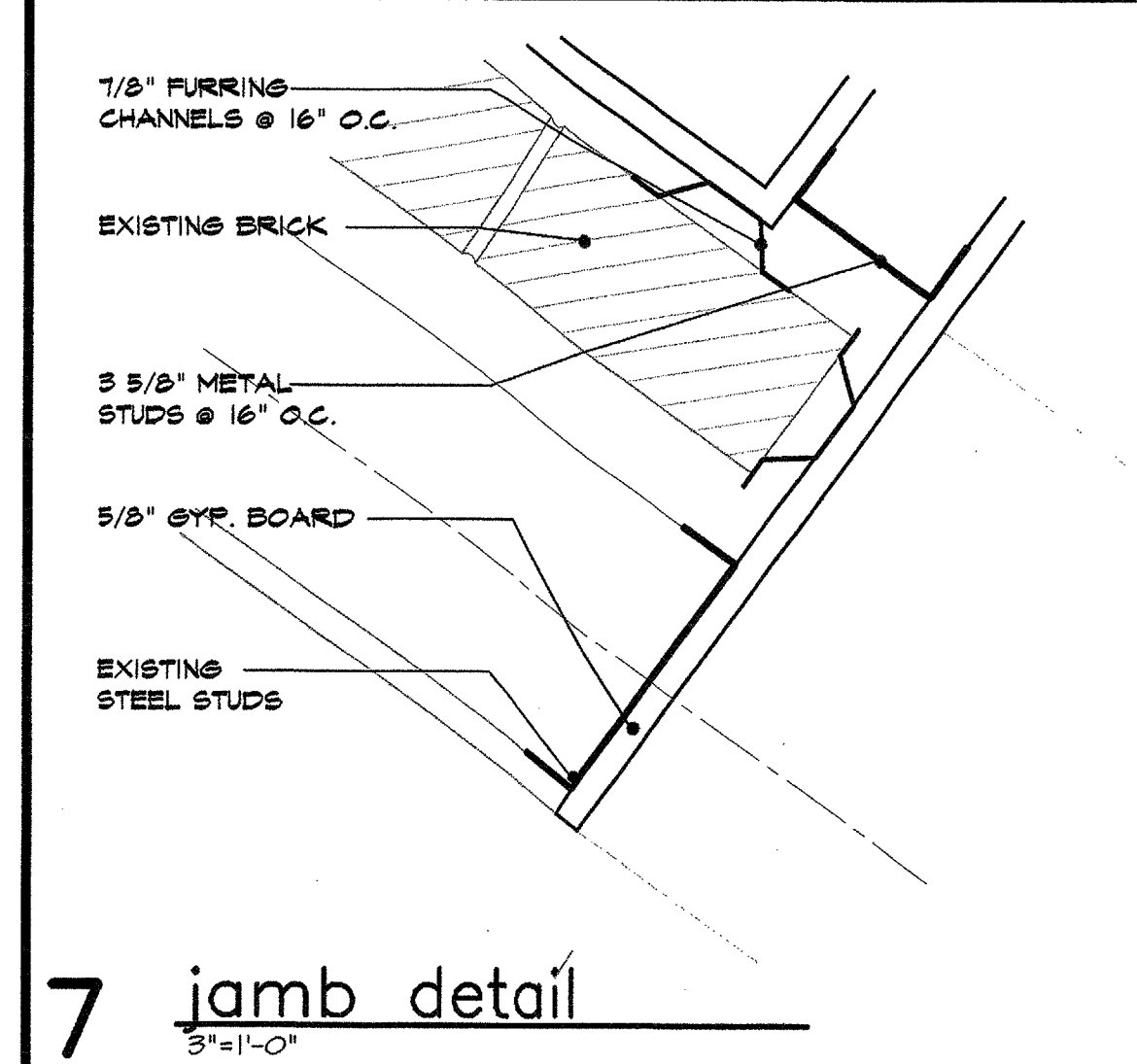

7 jamb detail
3"x11'-0"

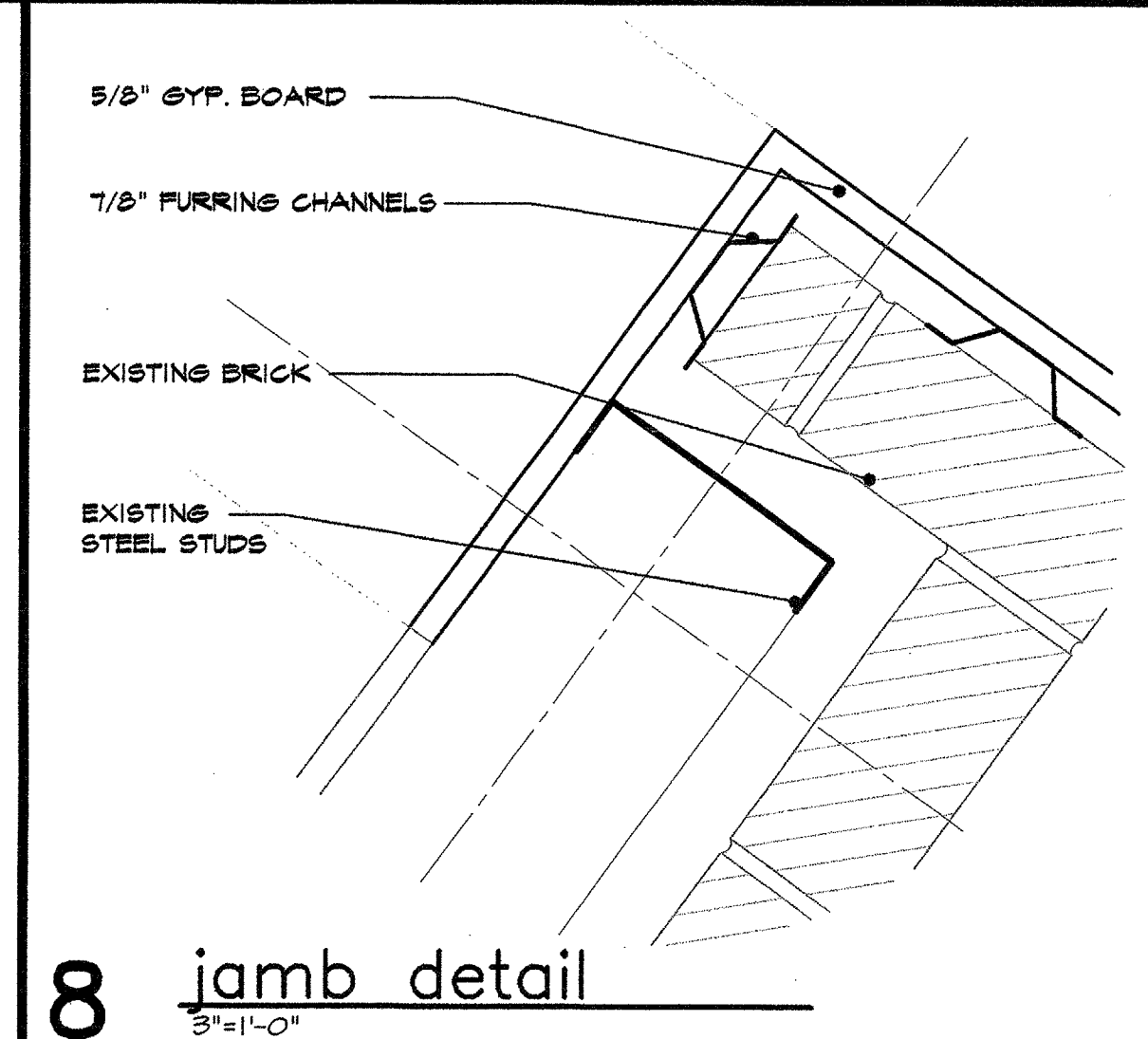

8 jamb detail
3"x11'-0"

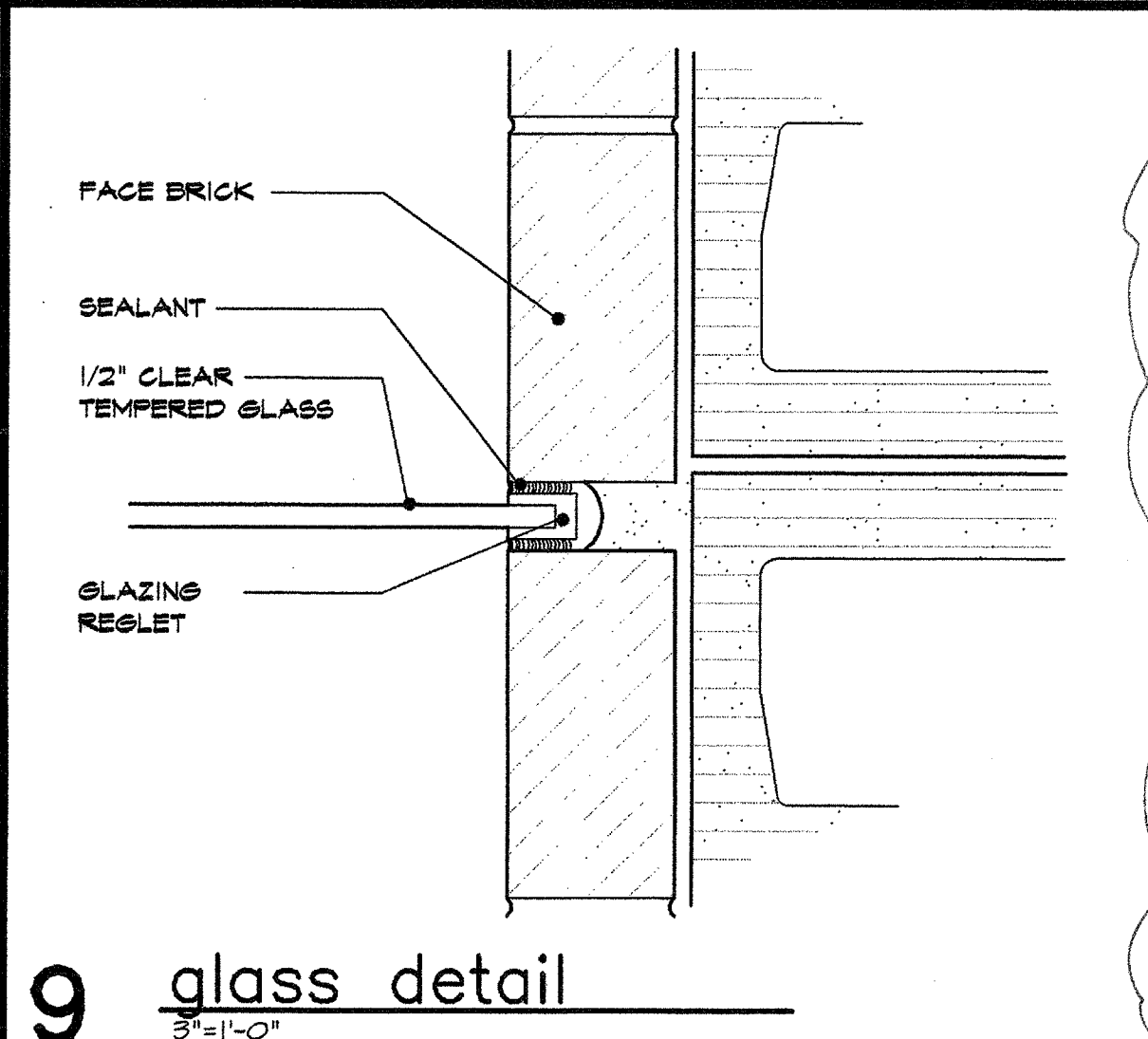

9 glass detail
3"x11'-0"

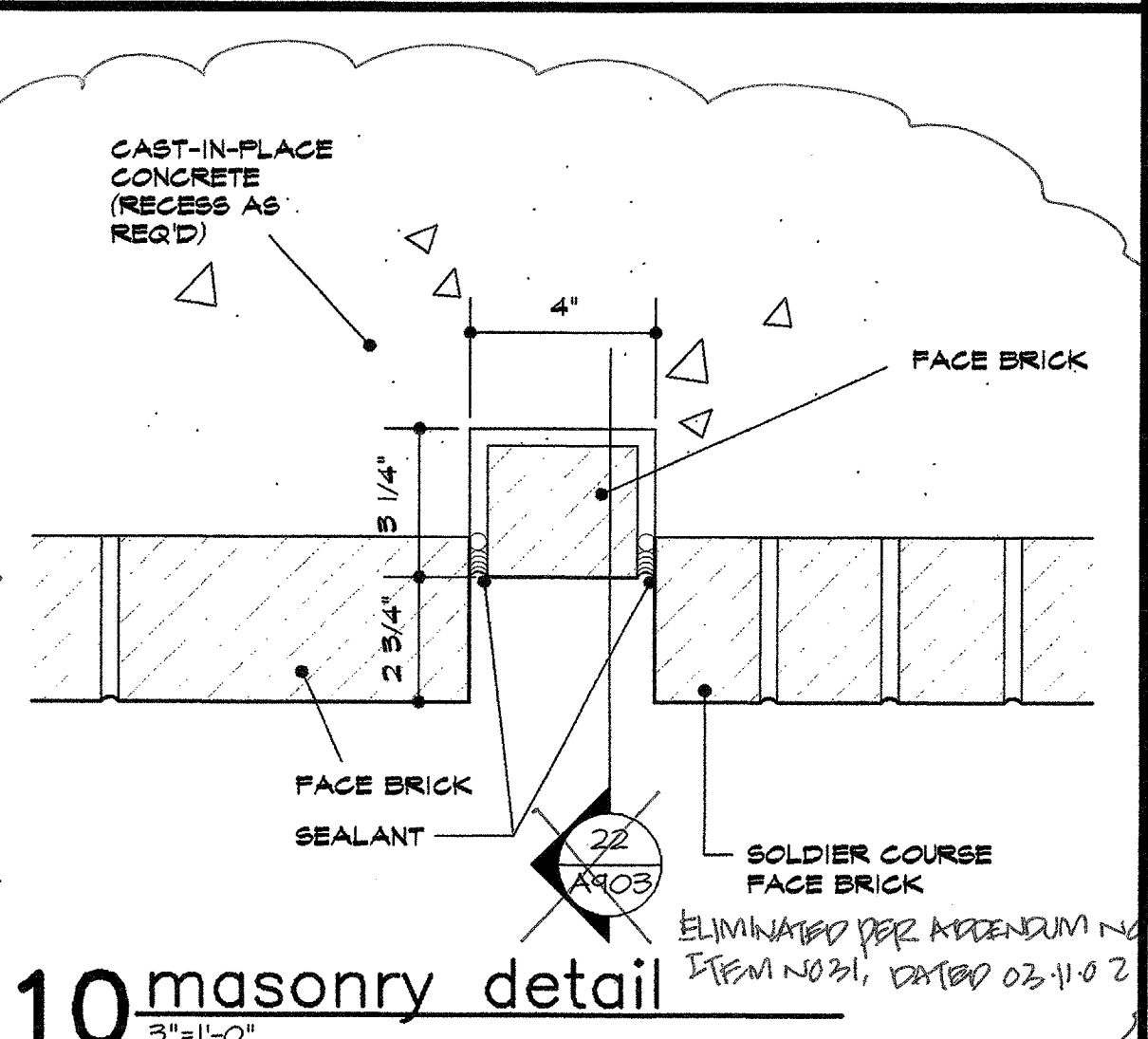

10 masonry detail
3"x11'-0"

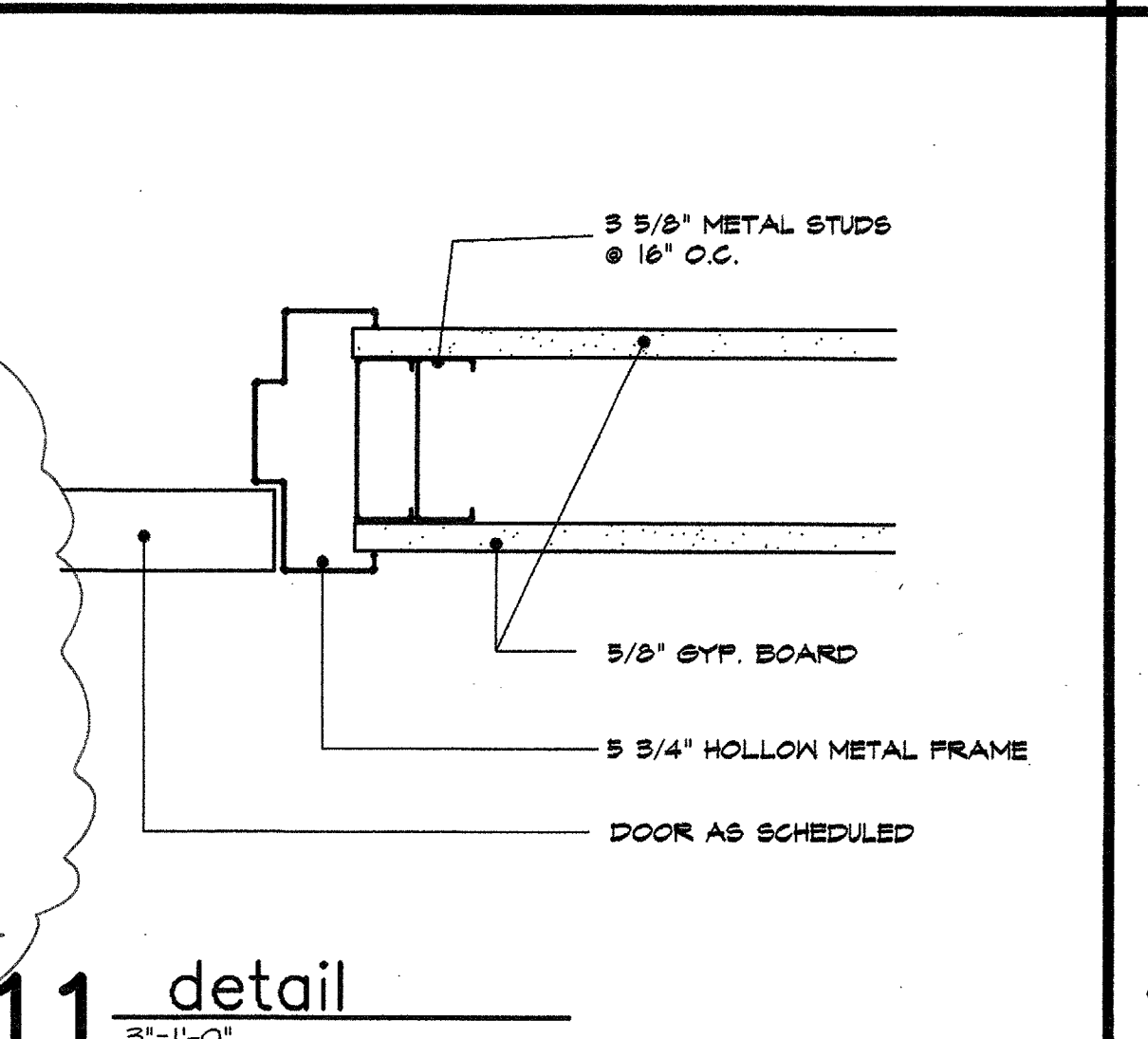

11 detail
3"x11'-0"

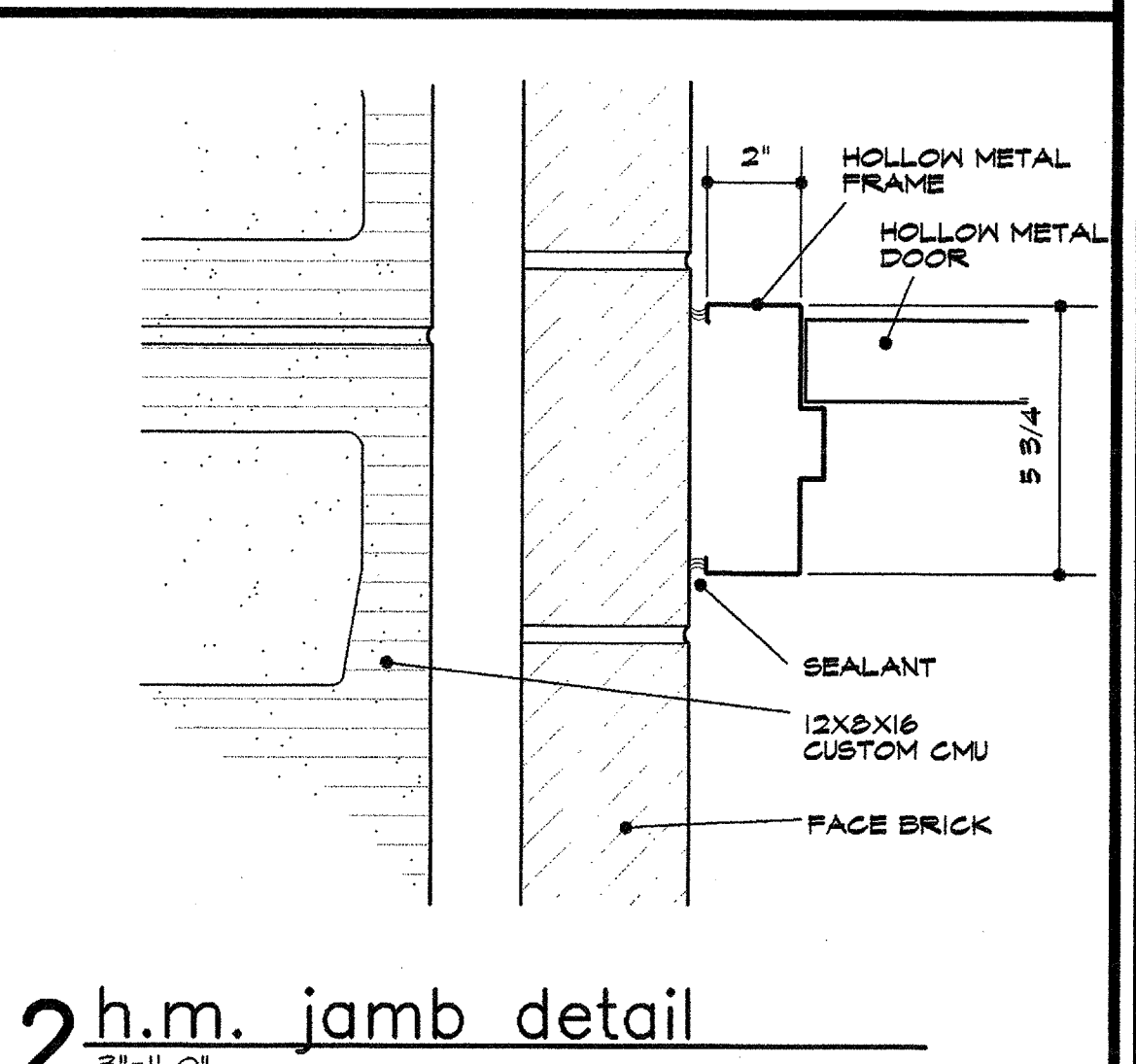

12 h.m. jamb detail
3"x11'-0"

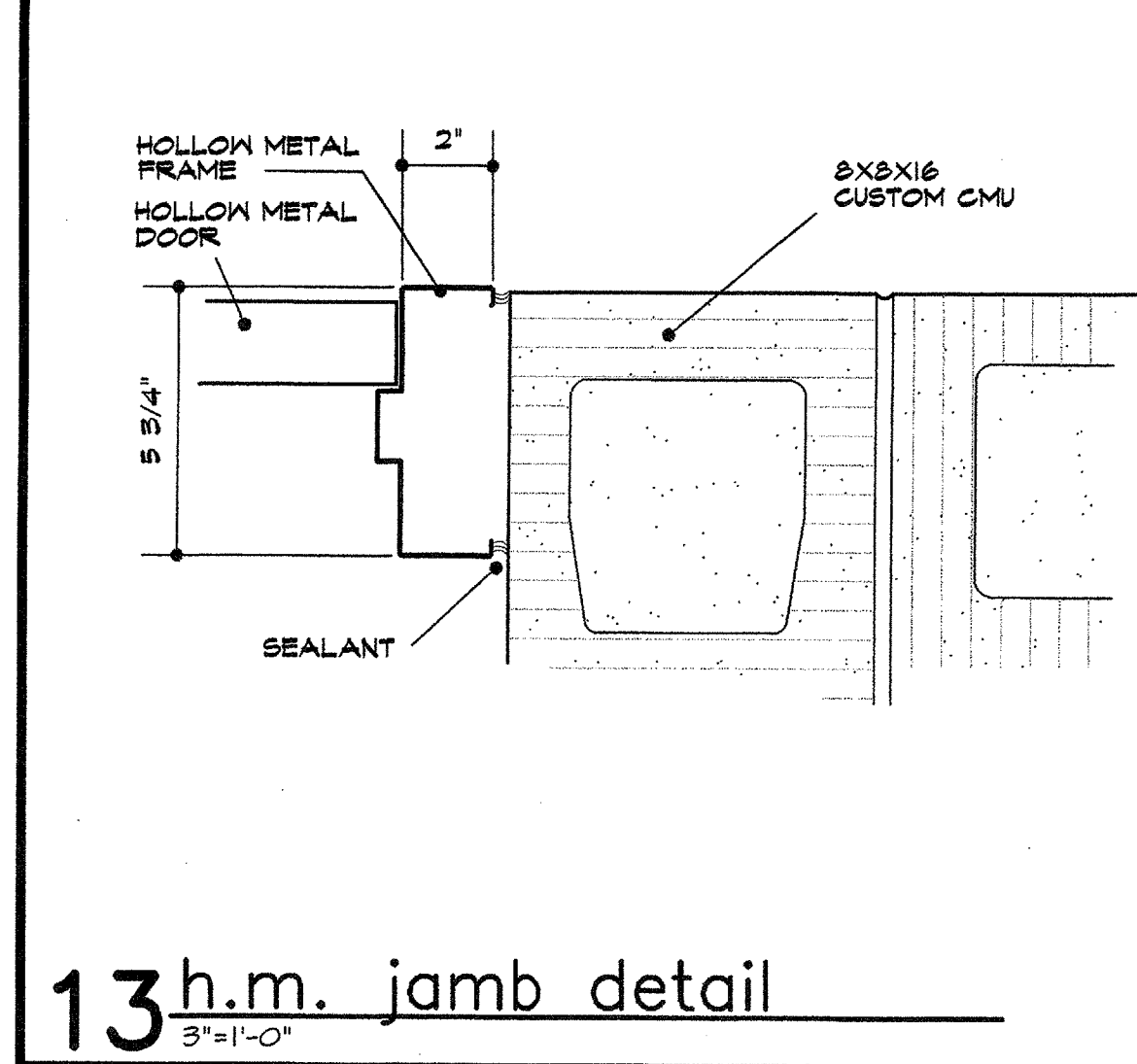

13 h.m. jamb detail
3"x11'-0"

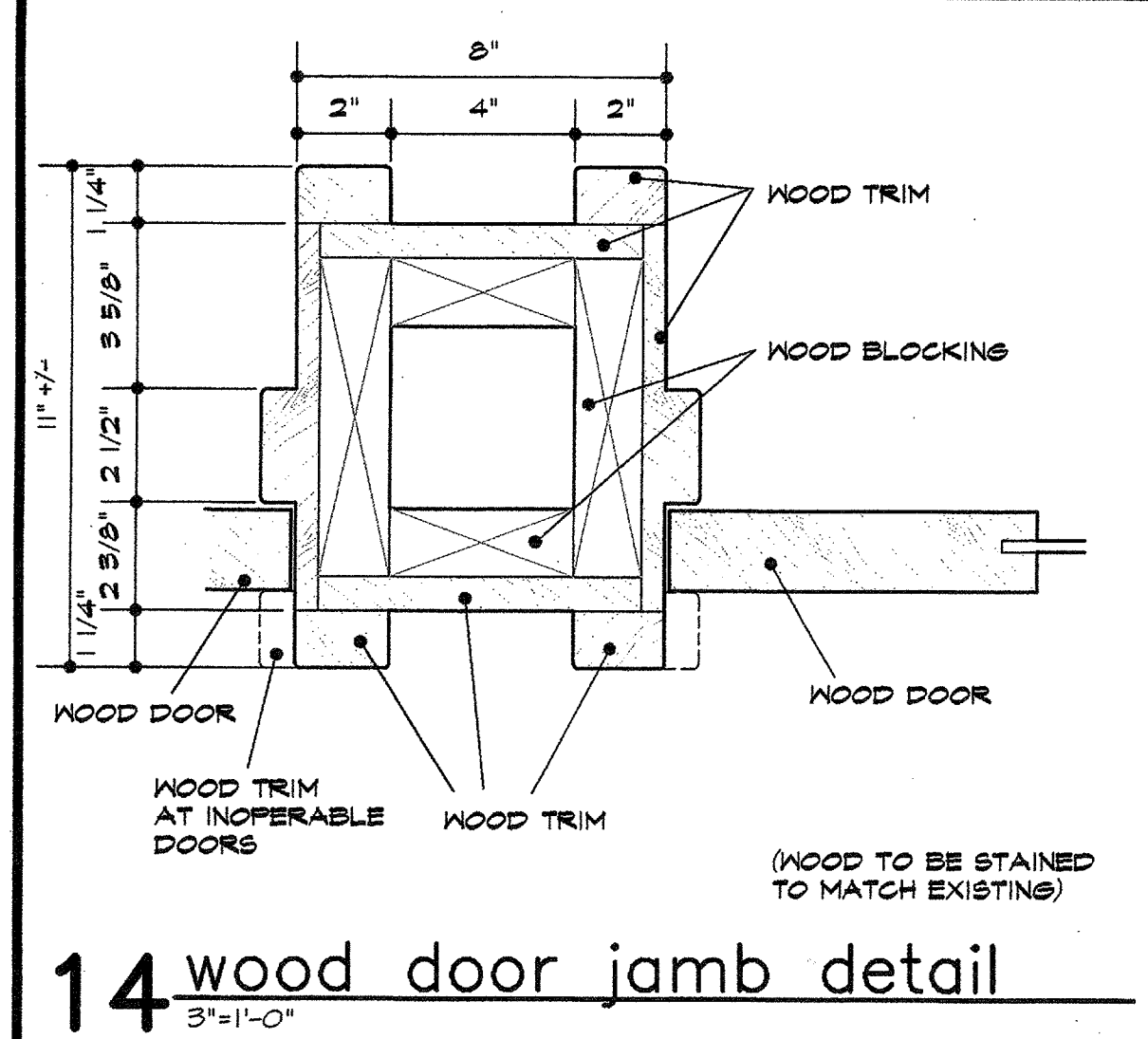

14 wood door jamb detail
3"x11'-0"

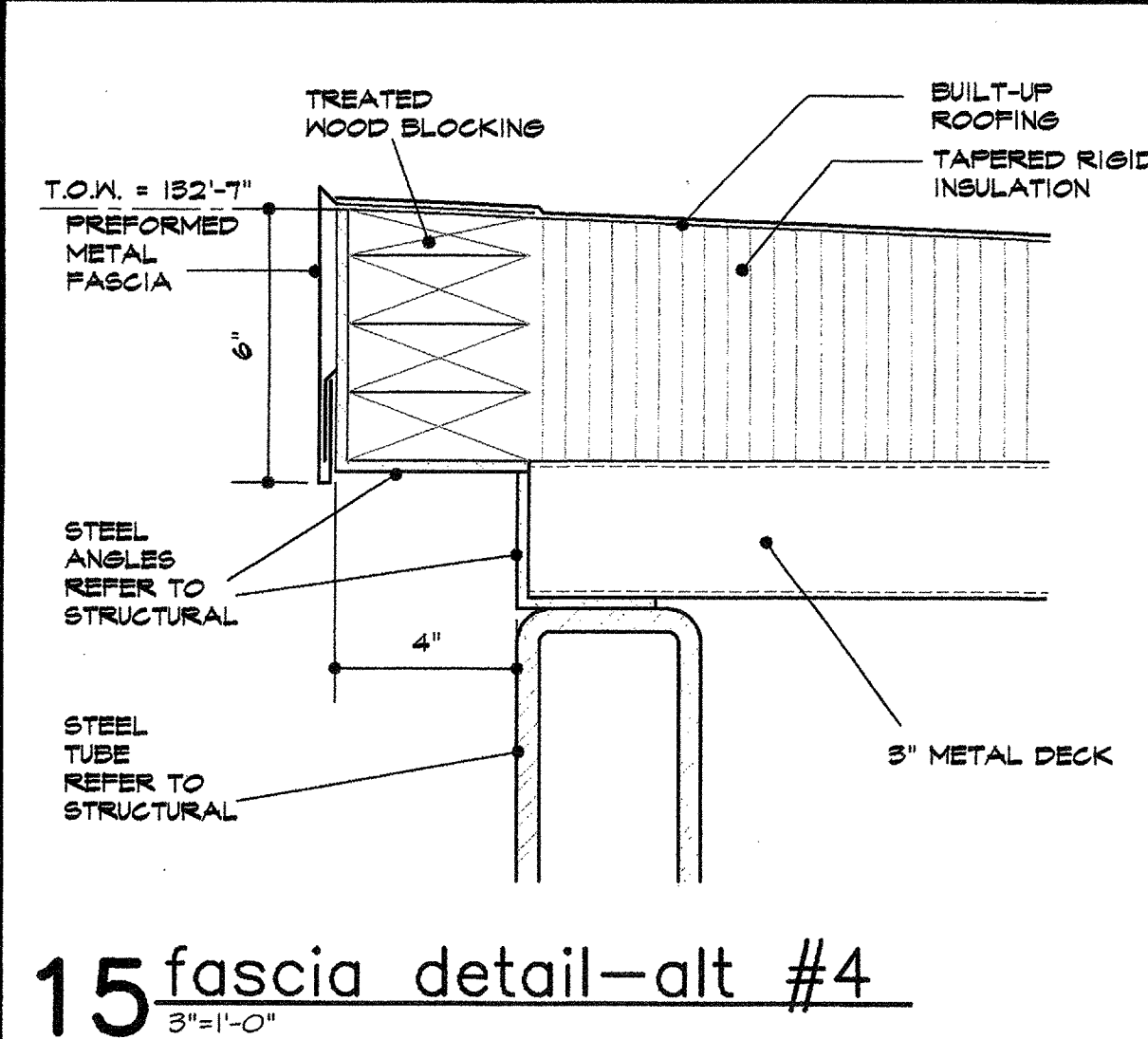

15 fascia detail-alt #4
3"x11'-0"

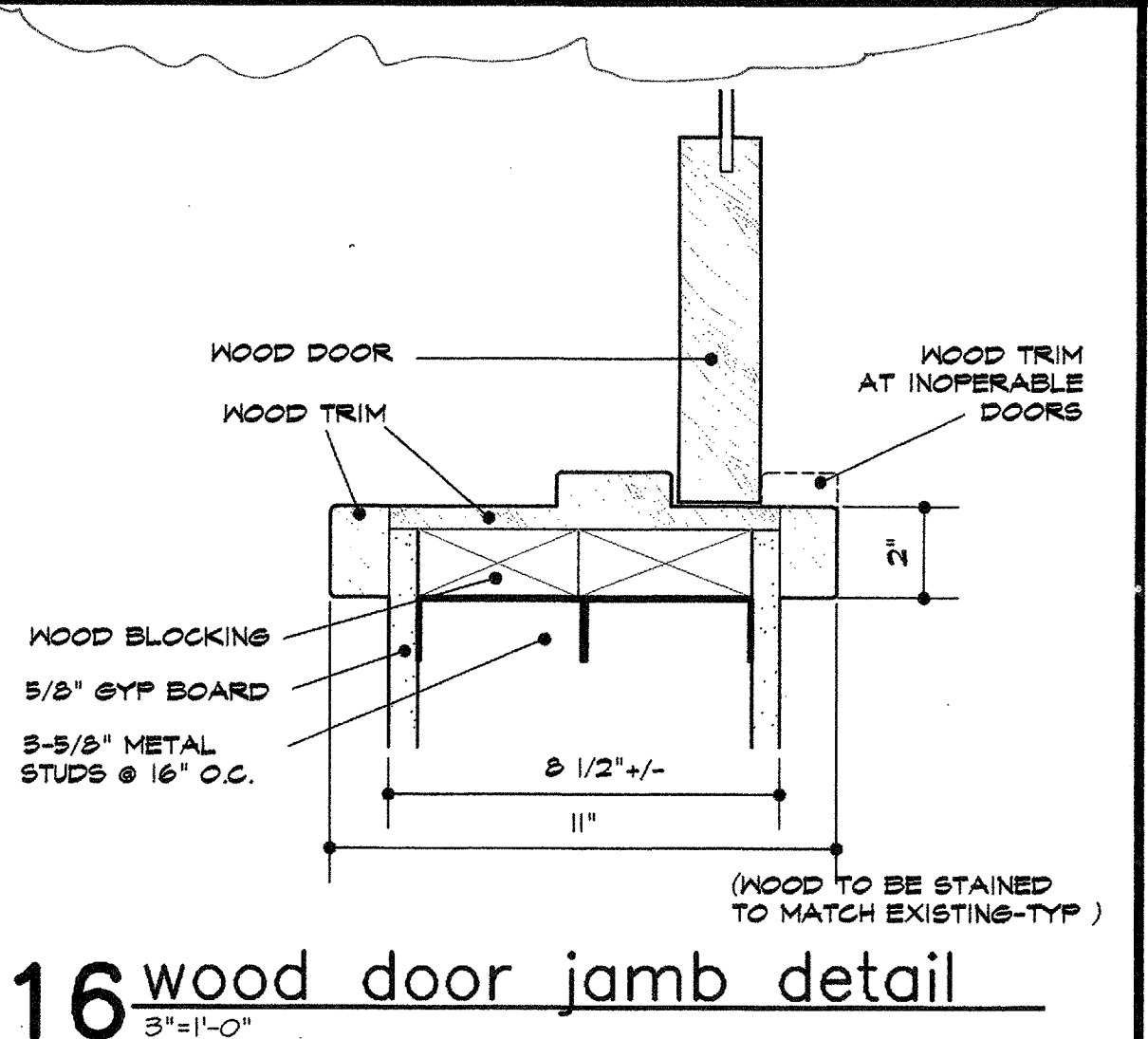

16 wood door jamb detail
3"x11'-0"

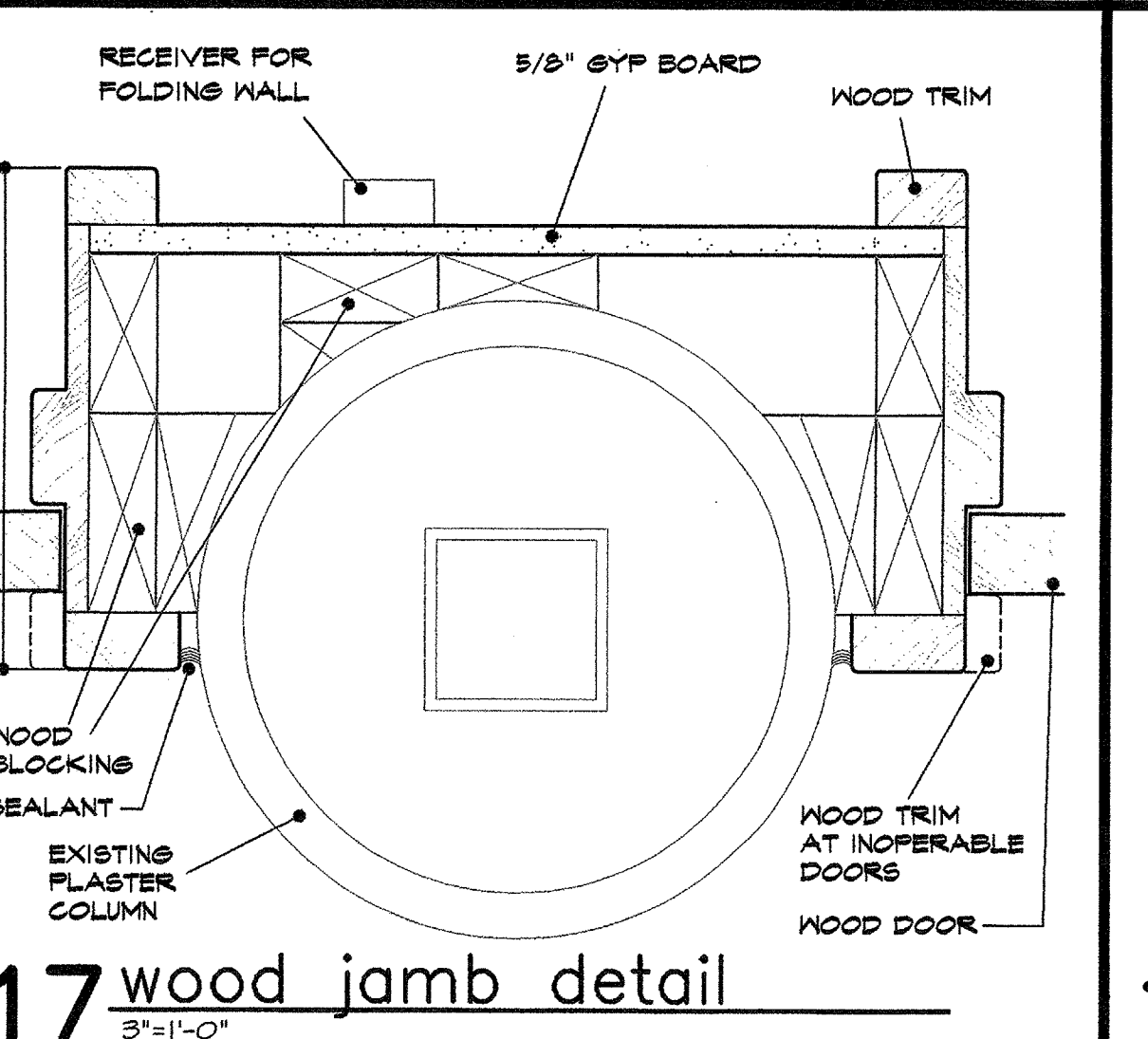

17 wood jamb detail
3"x11'-0"

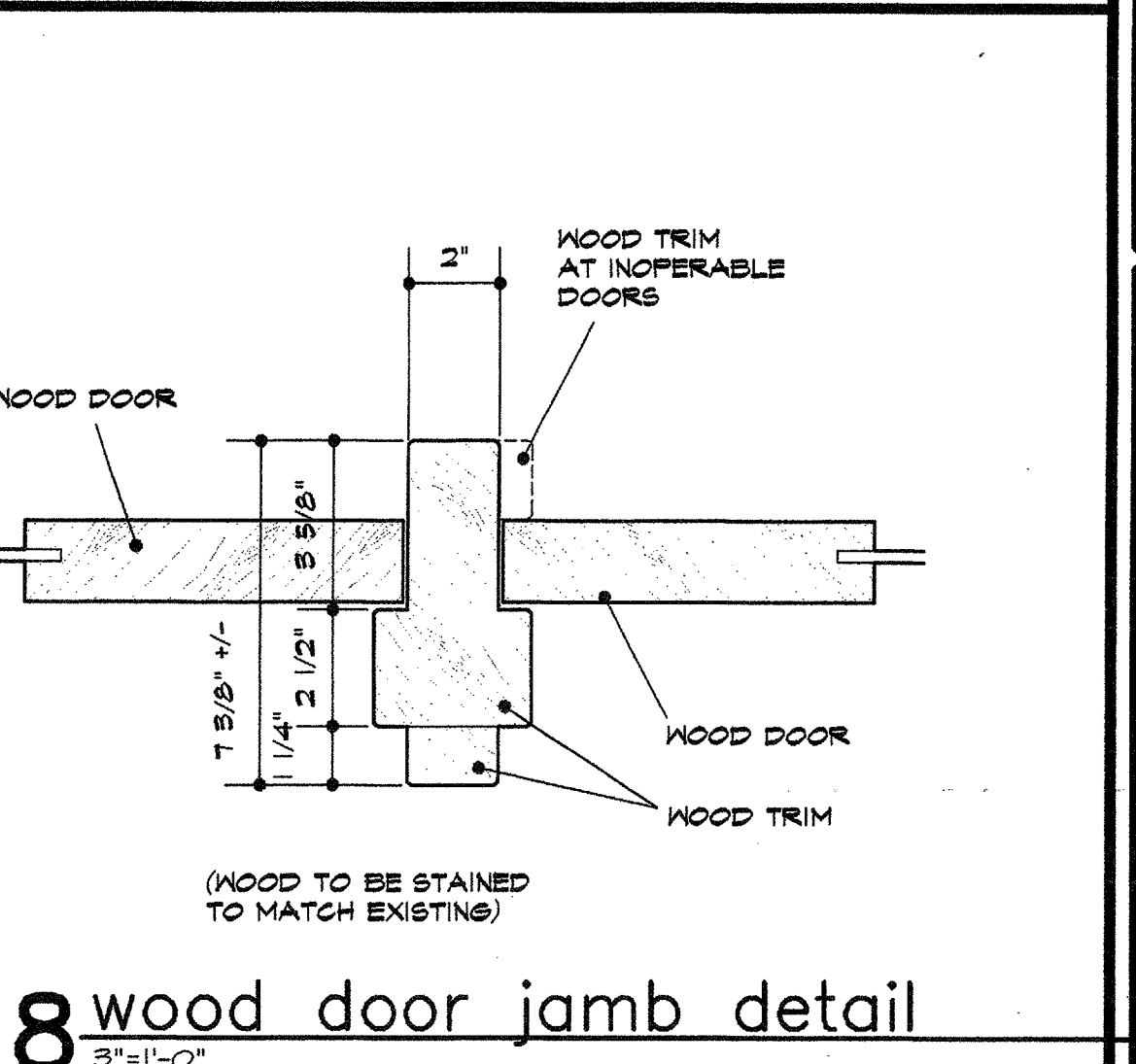

18 wood door jamb detail
3"x11'-0"

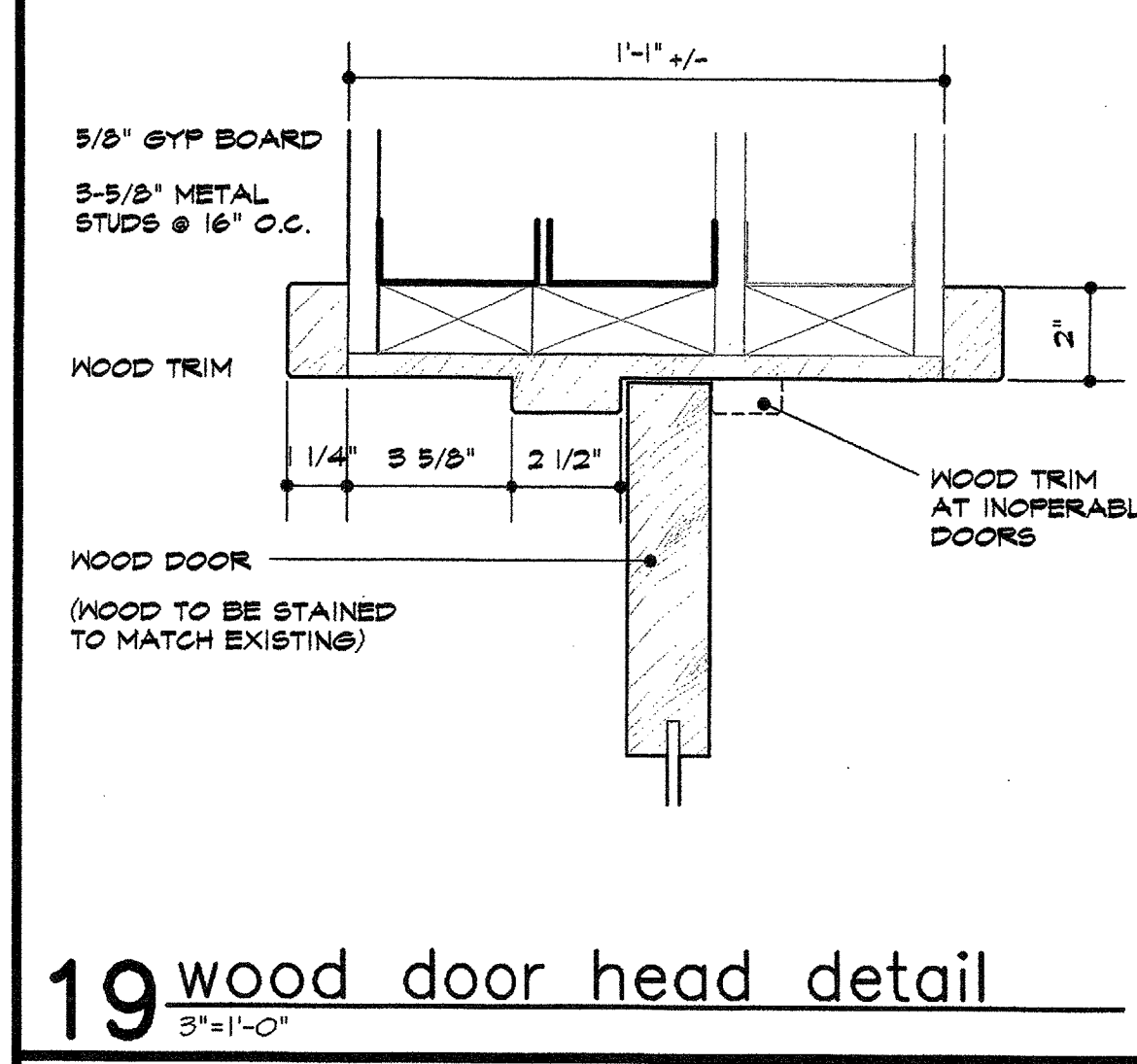

19 wood door head detail
3"x11'-0"

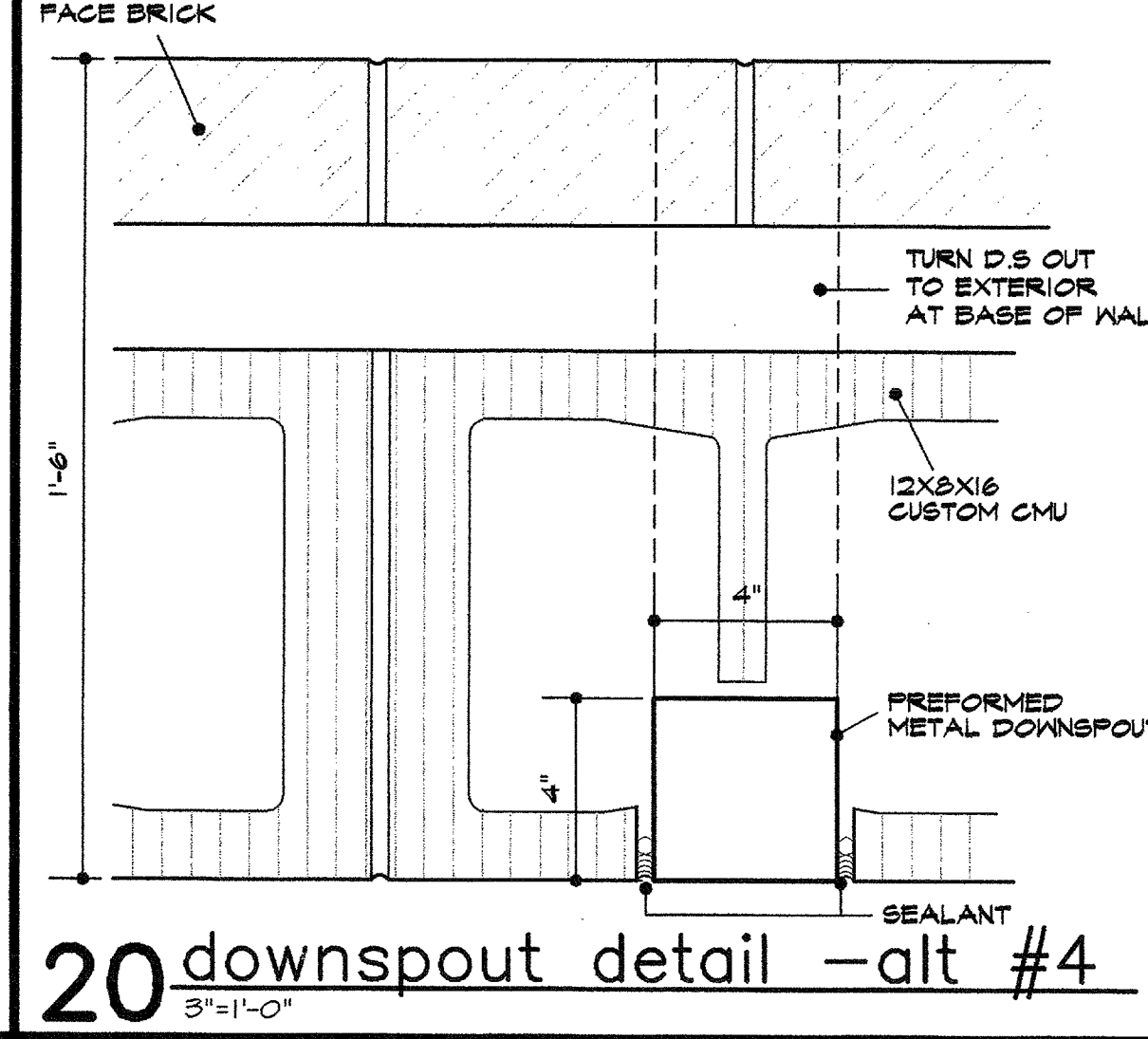

20 downspout detail -alt #4
3"x11'-0"

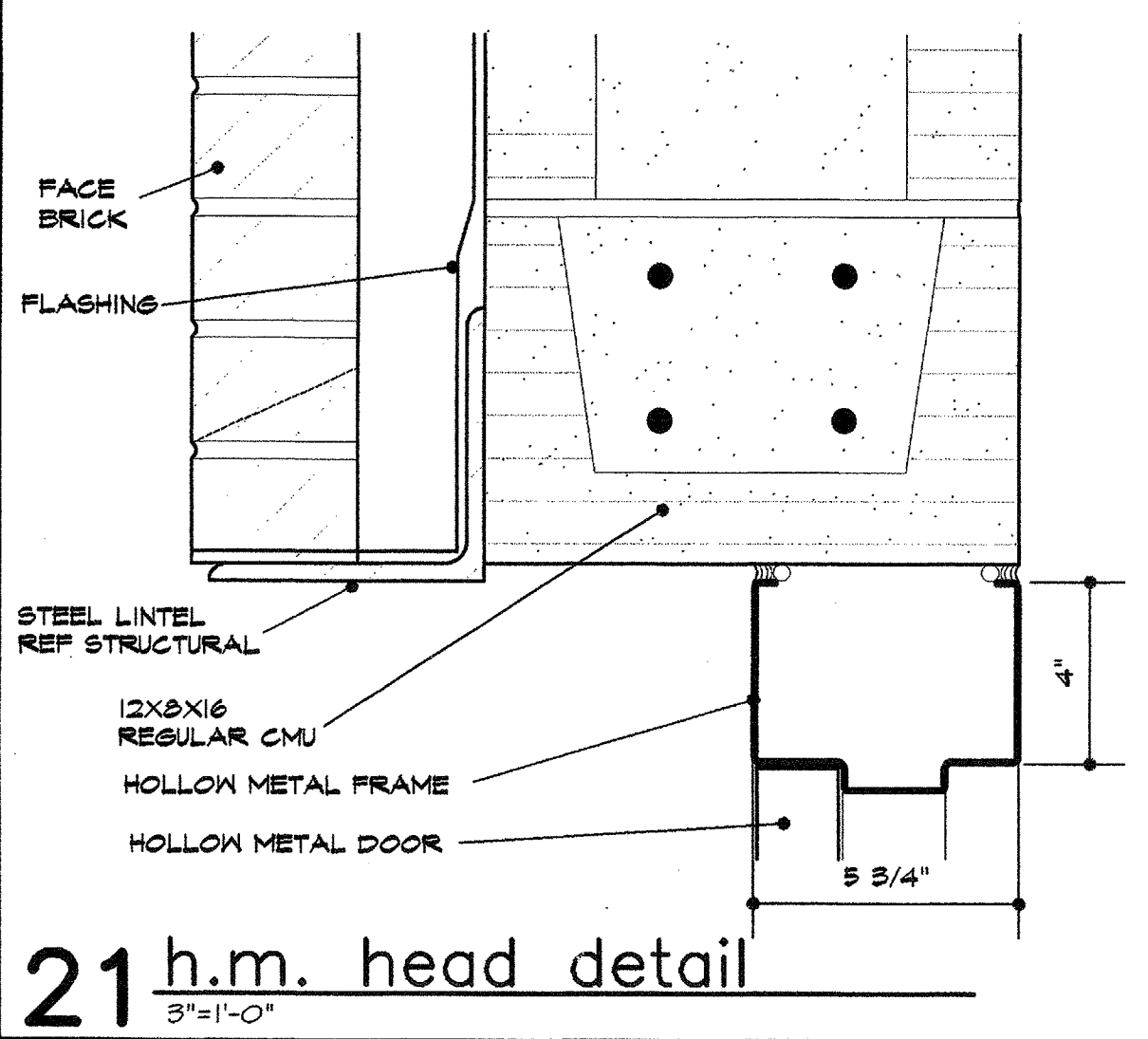

21 h.m. head detail
3"x11'-0"

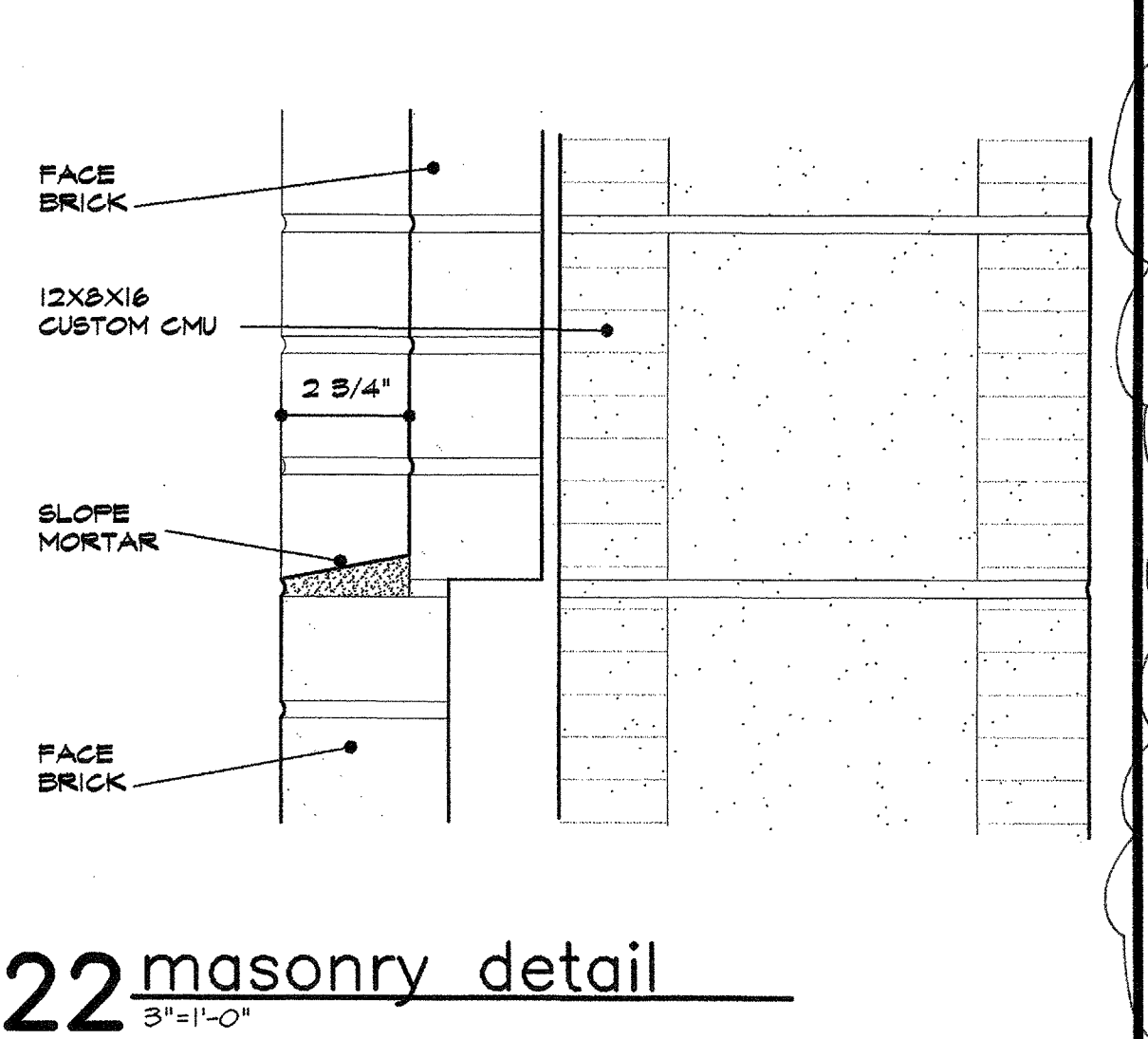

22 masonry detail
3"x11'-0"

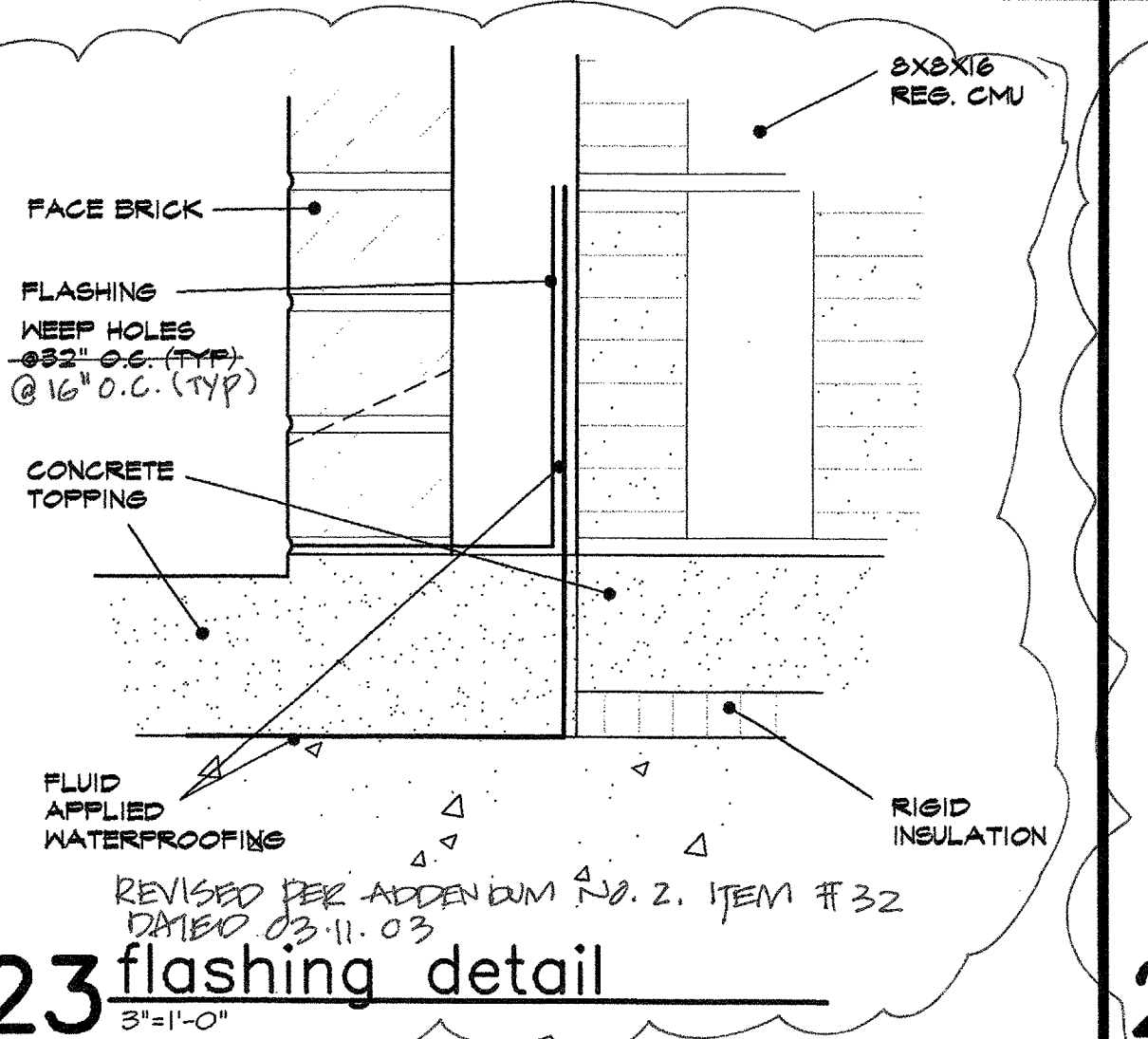

23 flashing detail
3"x11'-0"

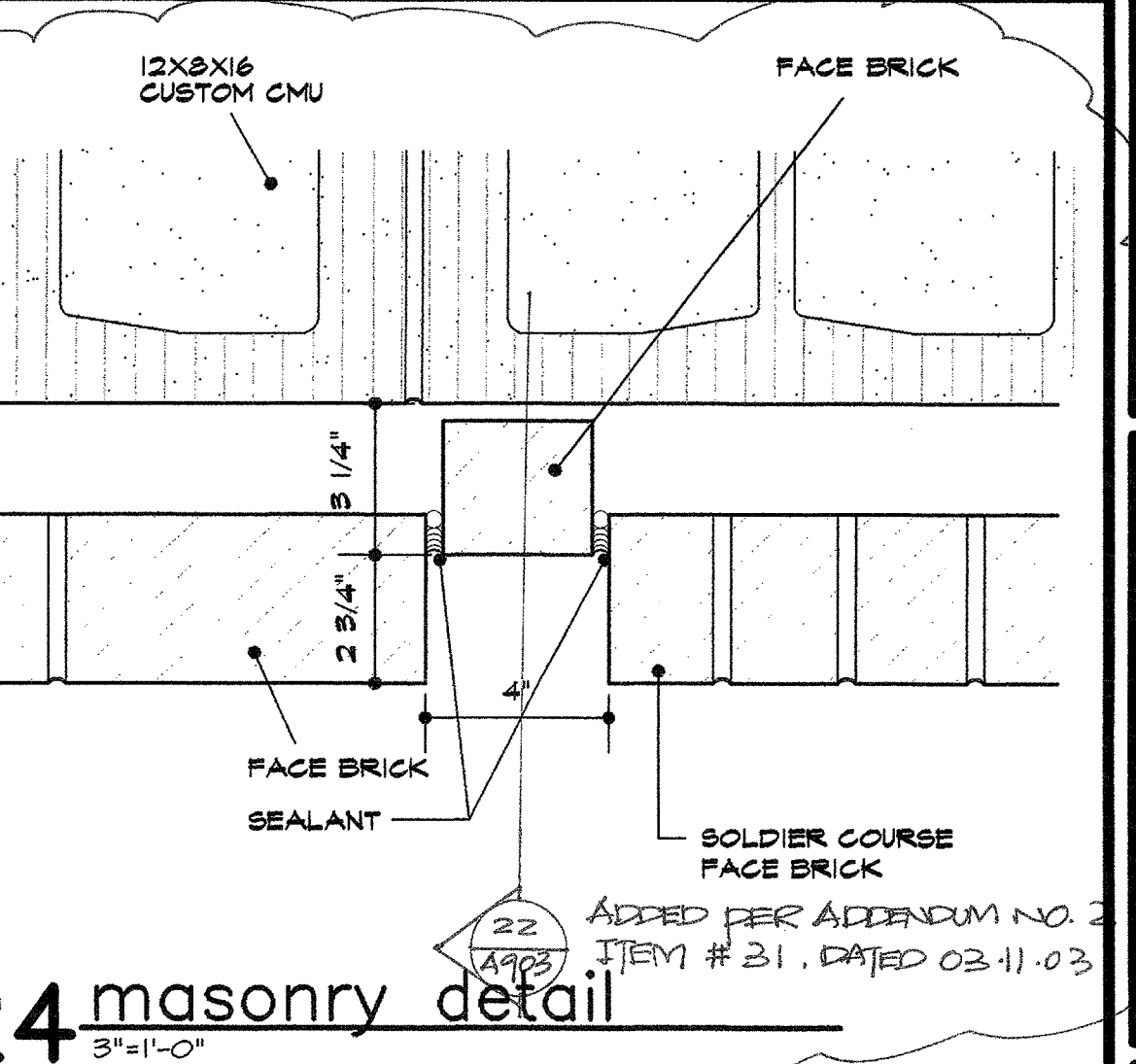

24 masonry detail
3"x11'-0"

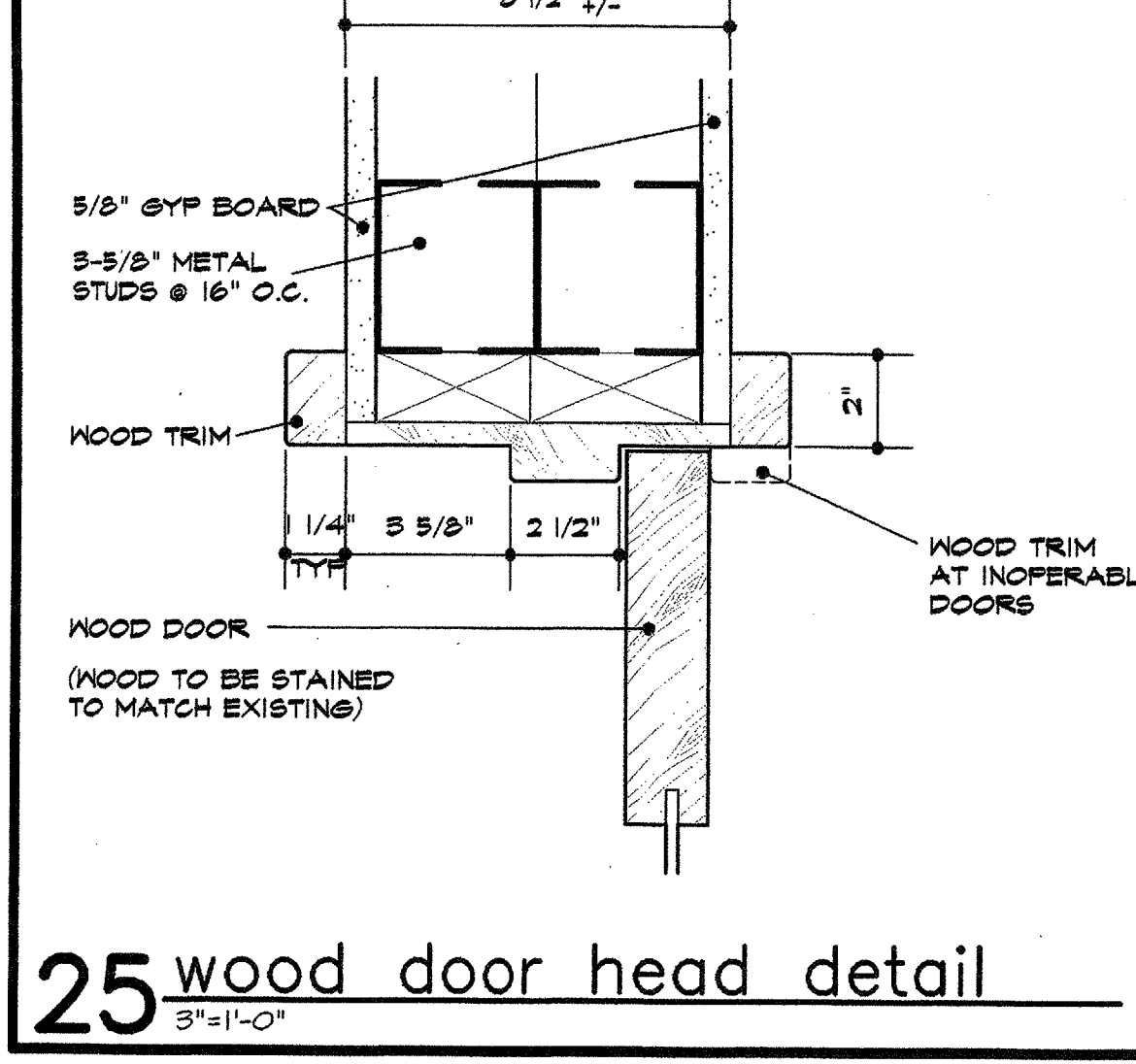

25 wood door head detail
3"x11'-0"

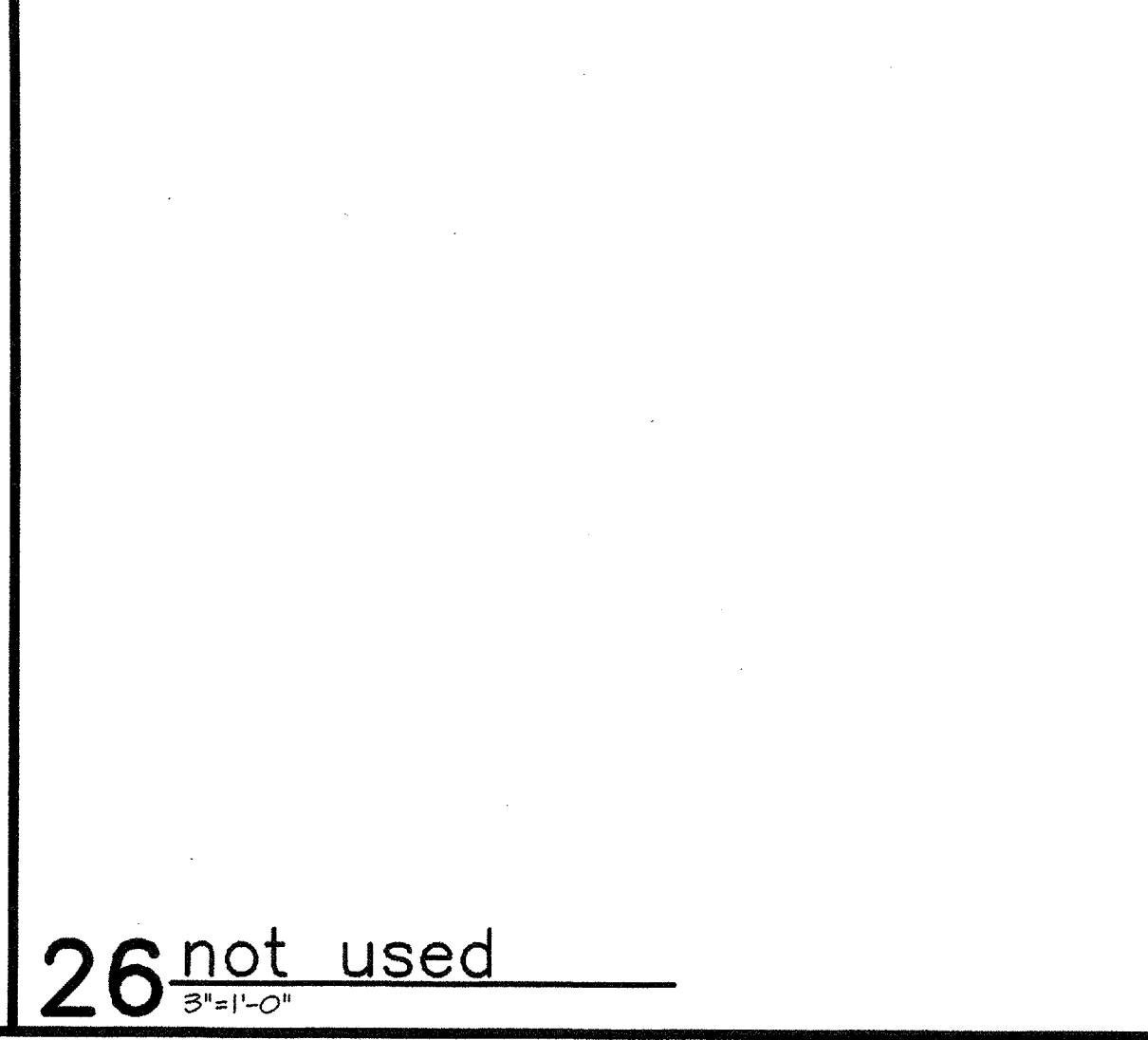

26 not used
3"x11'-0"

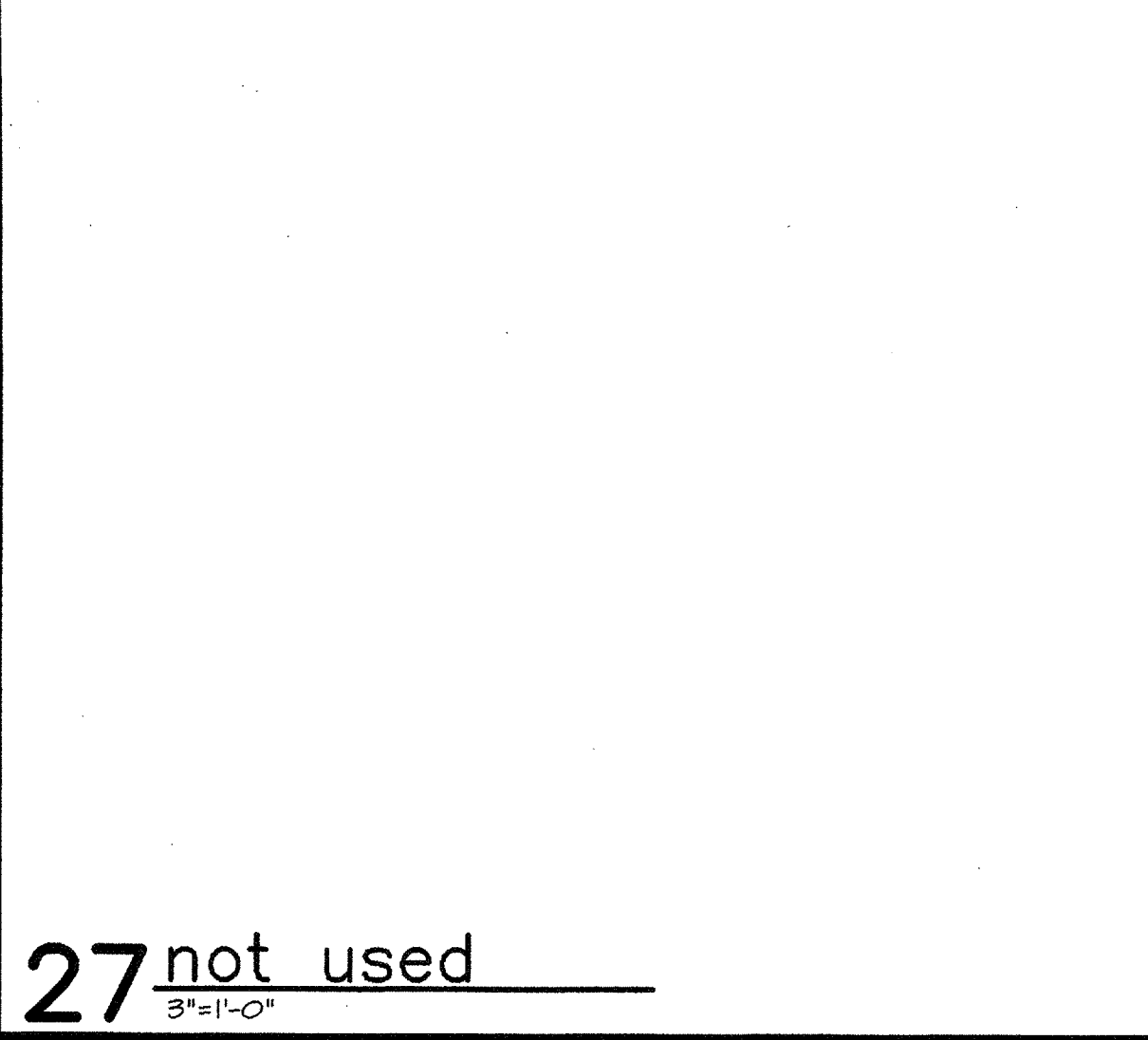

27 not used
3"x11'-0"

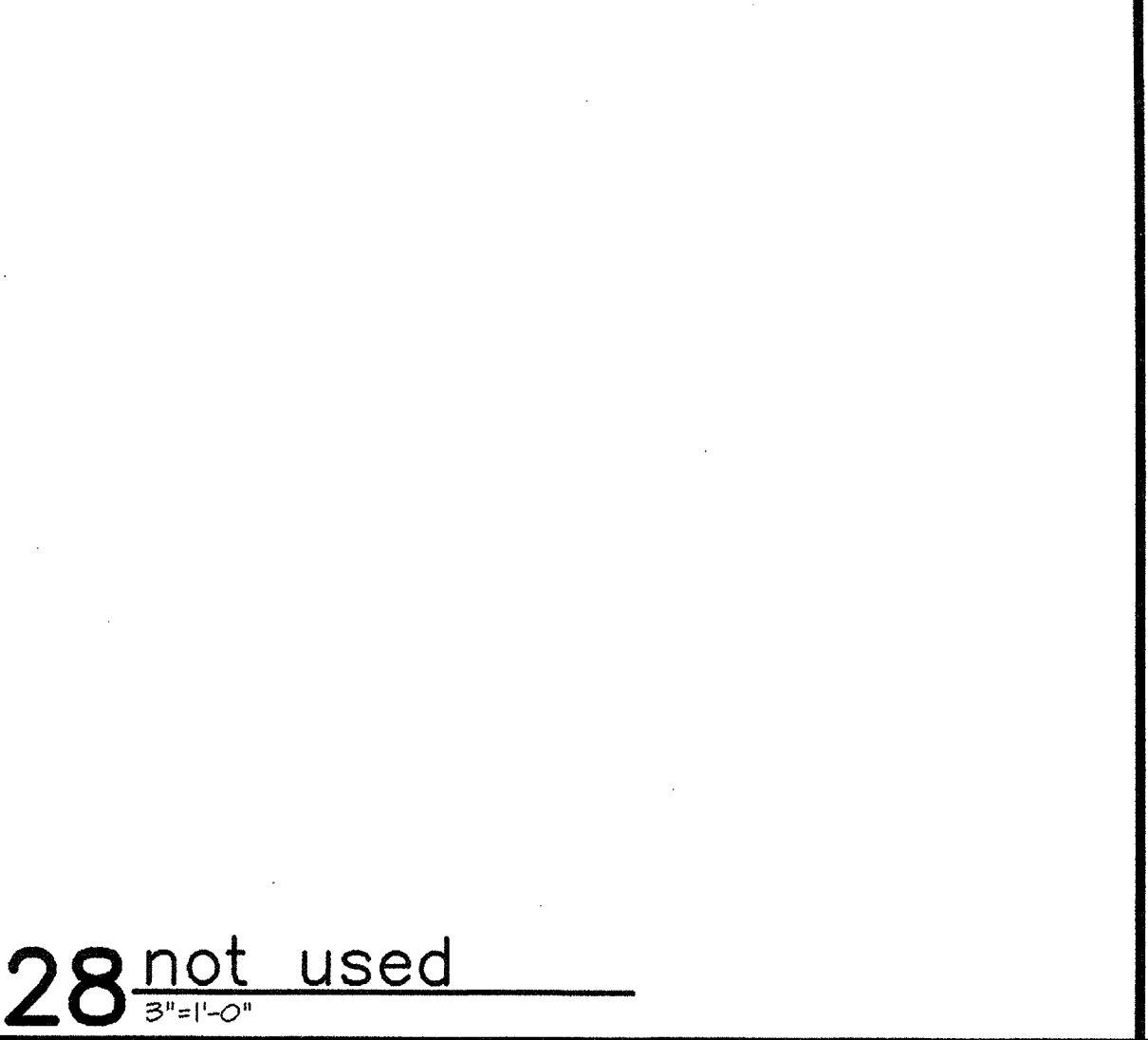

28 not used
3"x11'-0"

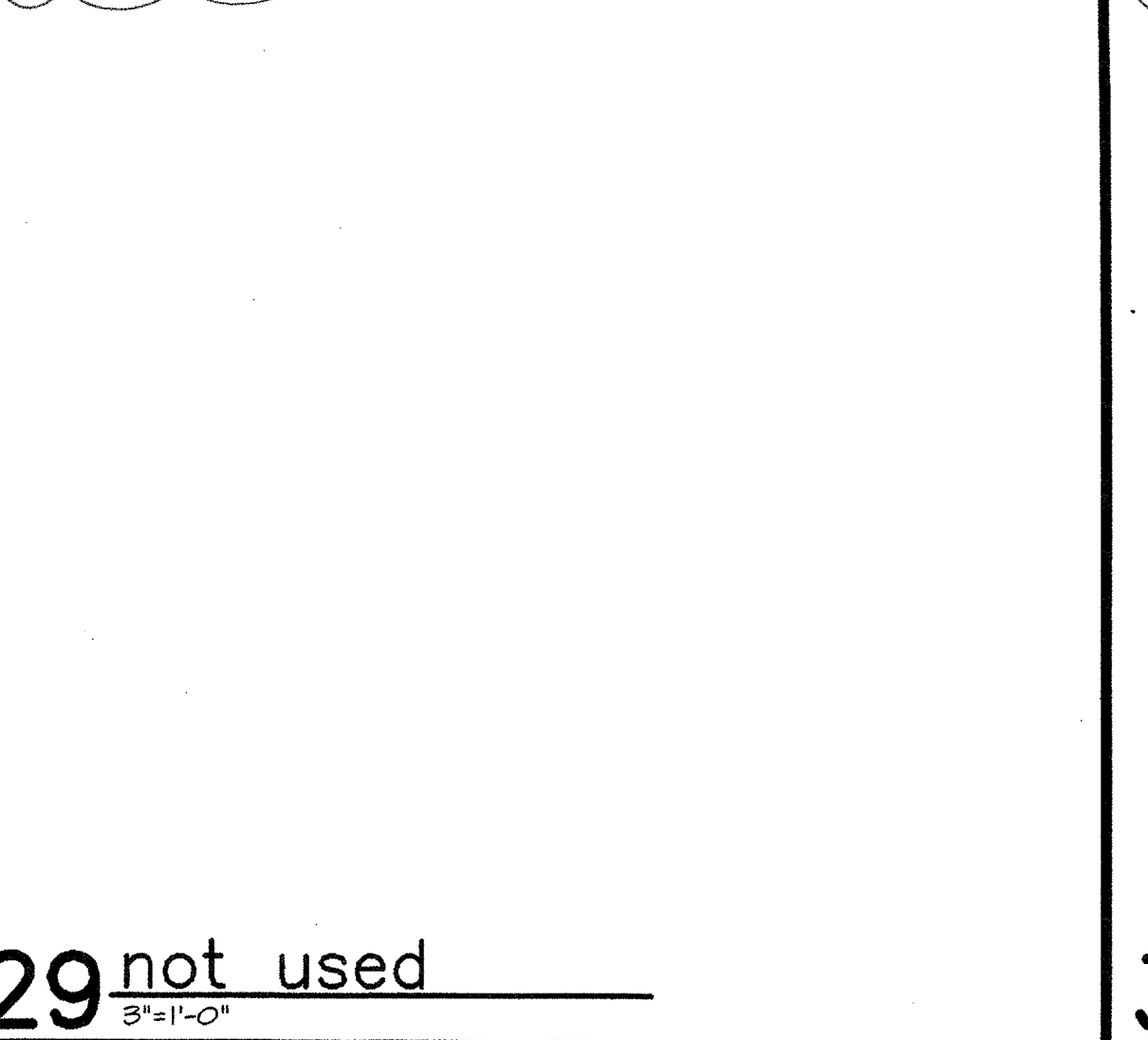

29 not used
3"x11'-0"

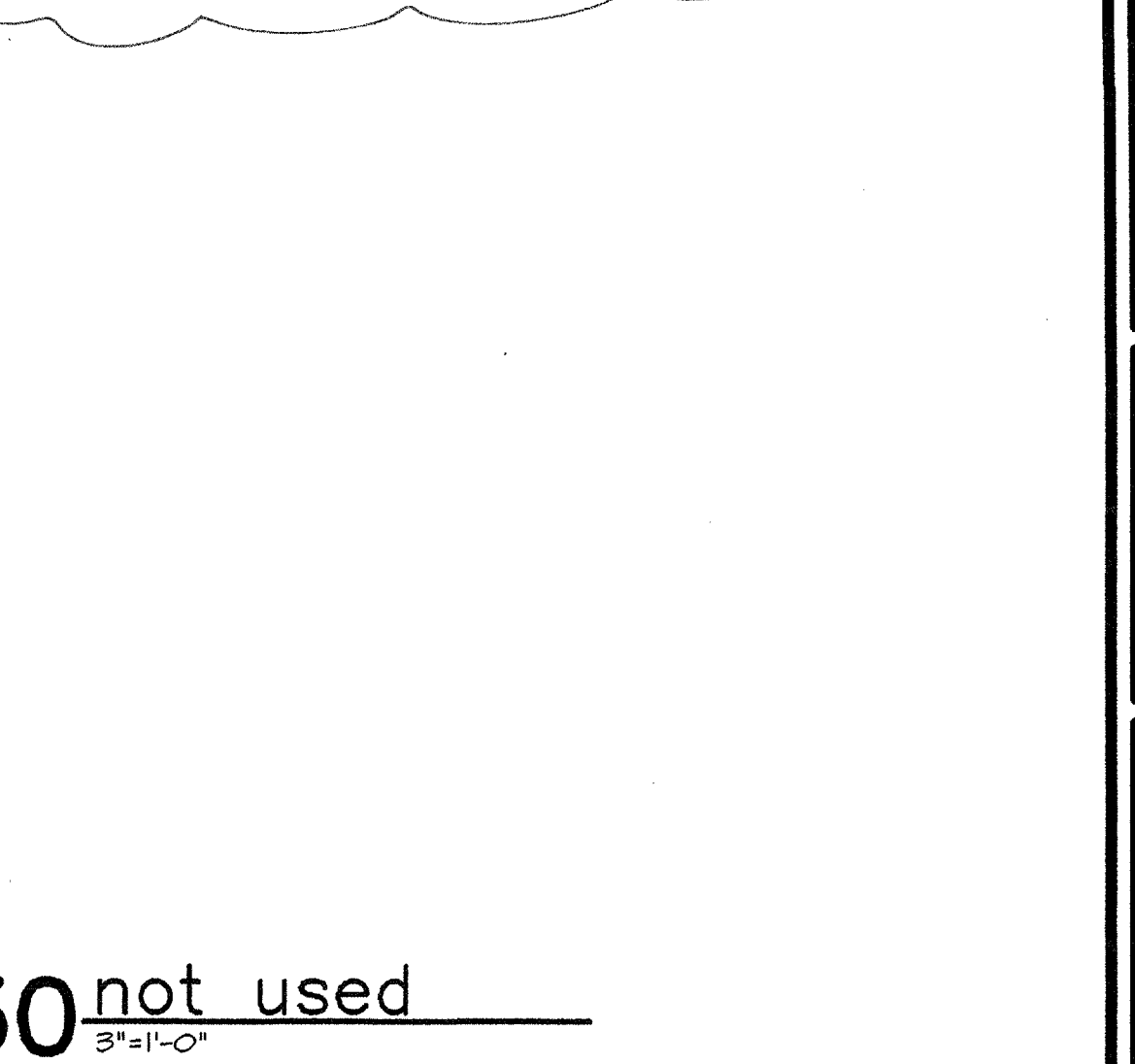

30 not used
3"x11'-0"

ISSUE DATE
FEB. 20, 2002
REVISIONS

ADDISON ATHLETIC CLUB EXPANSION
AND
LEISURE POOL
ADDISON, TEXAS

RON HOBBS ARCHITECTS
614 W. MAIN ST. SUITE #200 GARLAND, TEXAS 75040
972-944-0174

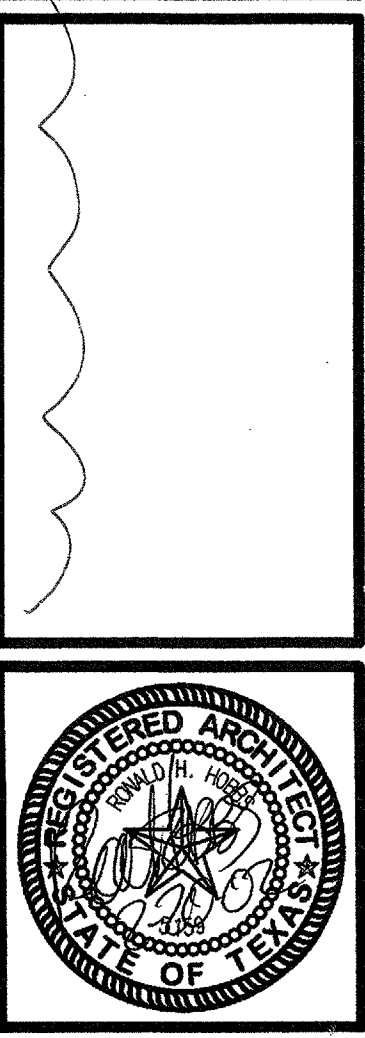

JOB NUMBER
0012
SHEET NAME
3" SCALE
DETAILS
SHEET NUMBER
A903