

SHEET NO.	
BASE	
DATE	
BY	
CHK'D	
DATE	

ADDISON RECREATION CENTER
 3900 BELTWAY DRIVE
 ADDISON, TEXAS

ADDISON

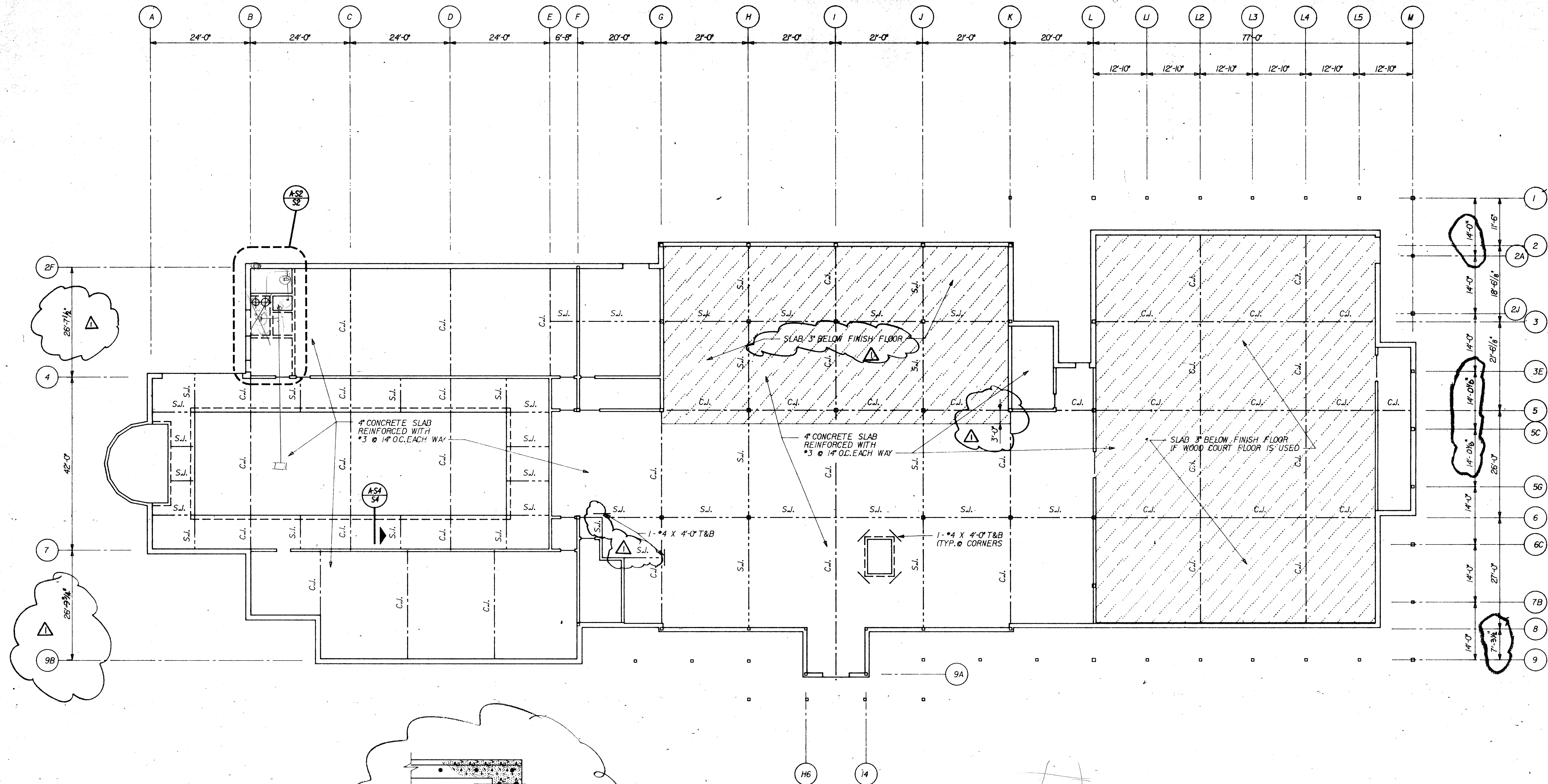

FIRST FLOOR SLAB PLAN

FINISH FLOOR EL. 605'-6"

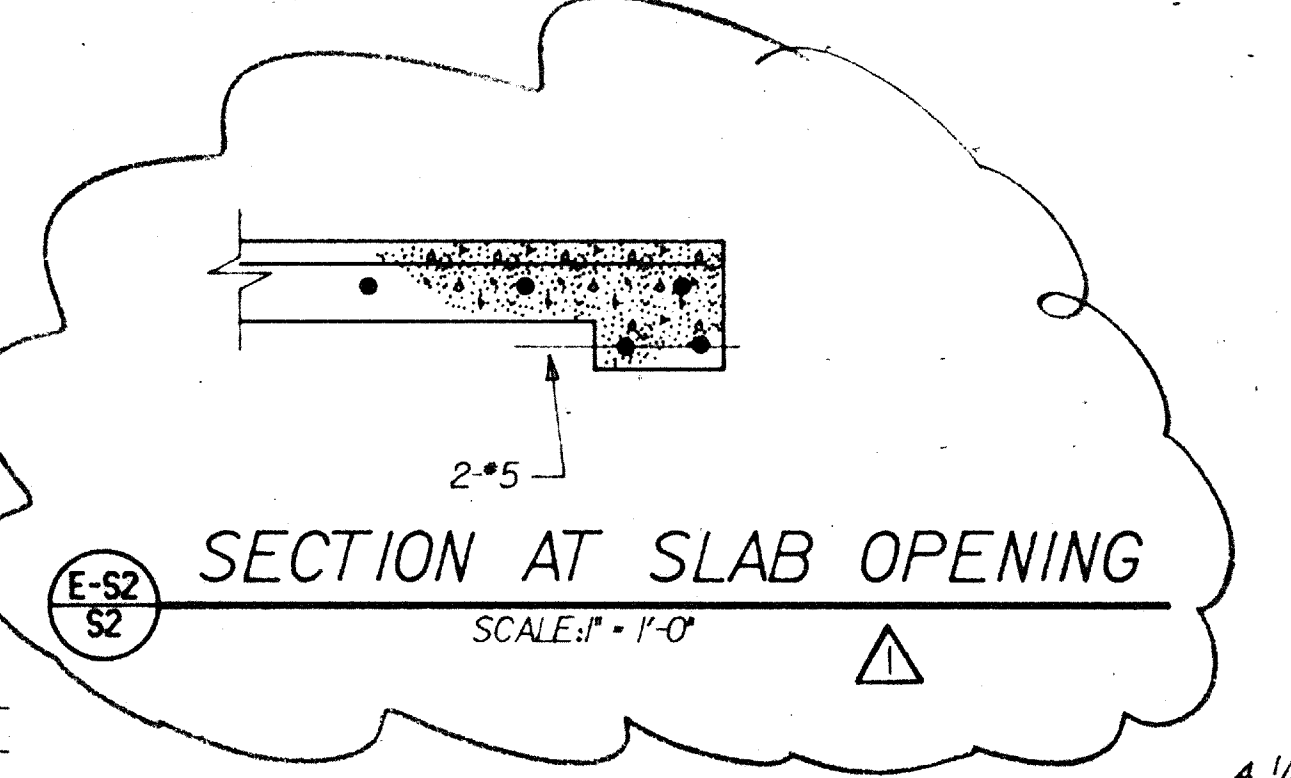

SECTION AT SLAB OPENING

SCALE: 1/2" = 1'-0"

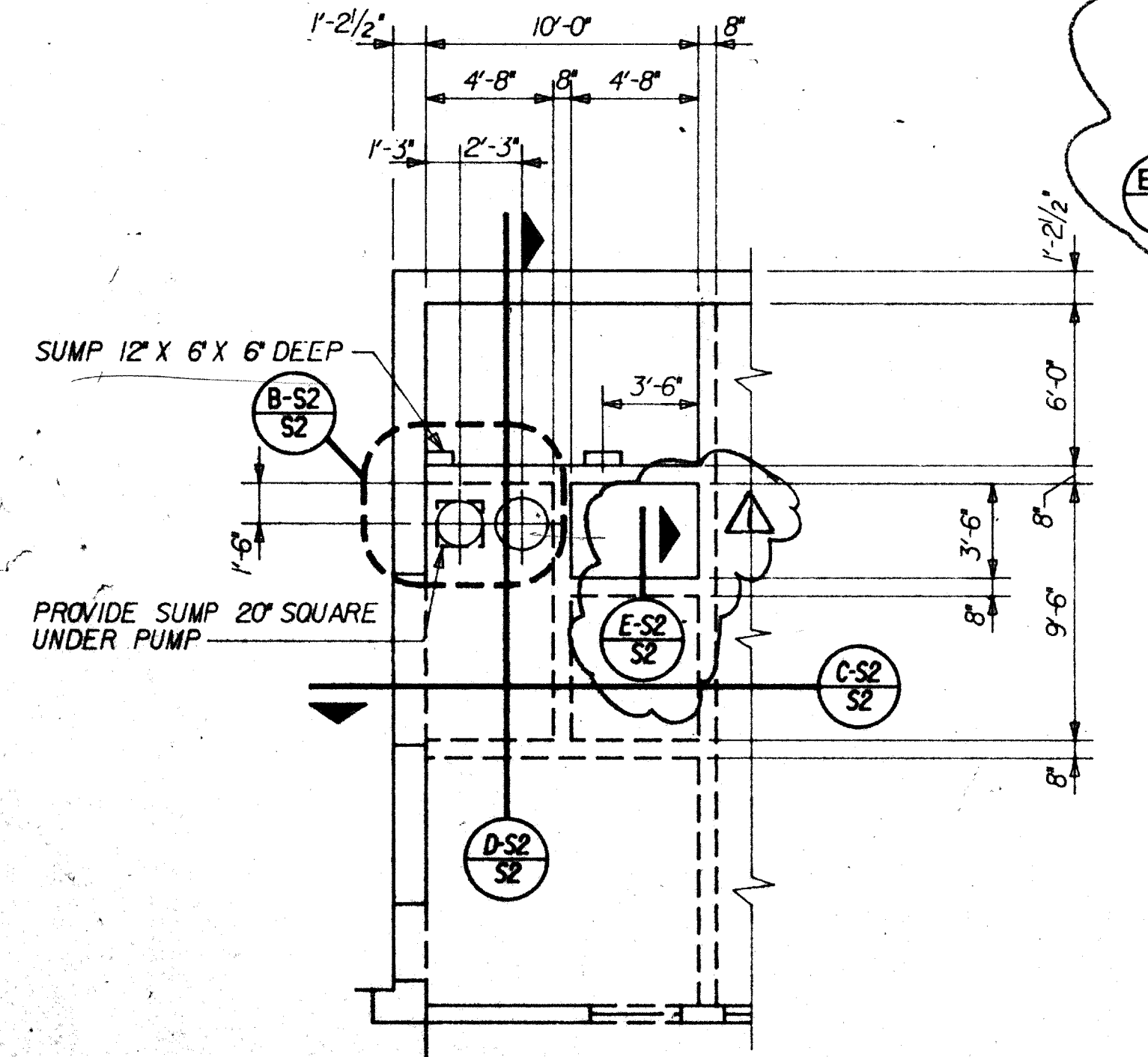

DETAIL AT POOL SUMPS

SCALE: 1/2" = 1'-0"

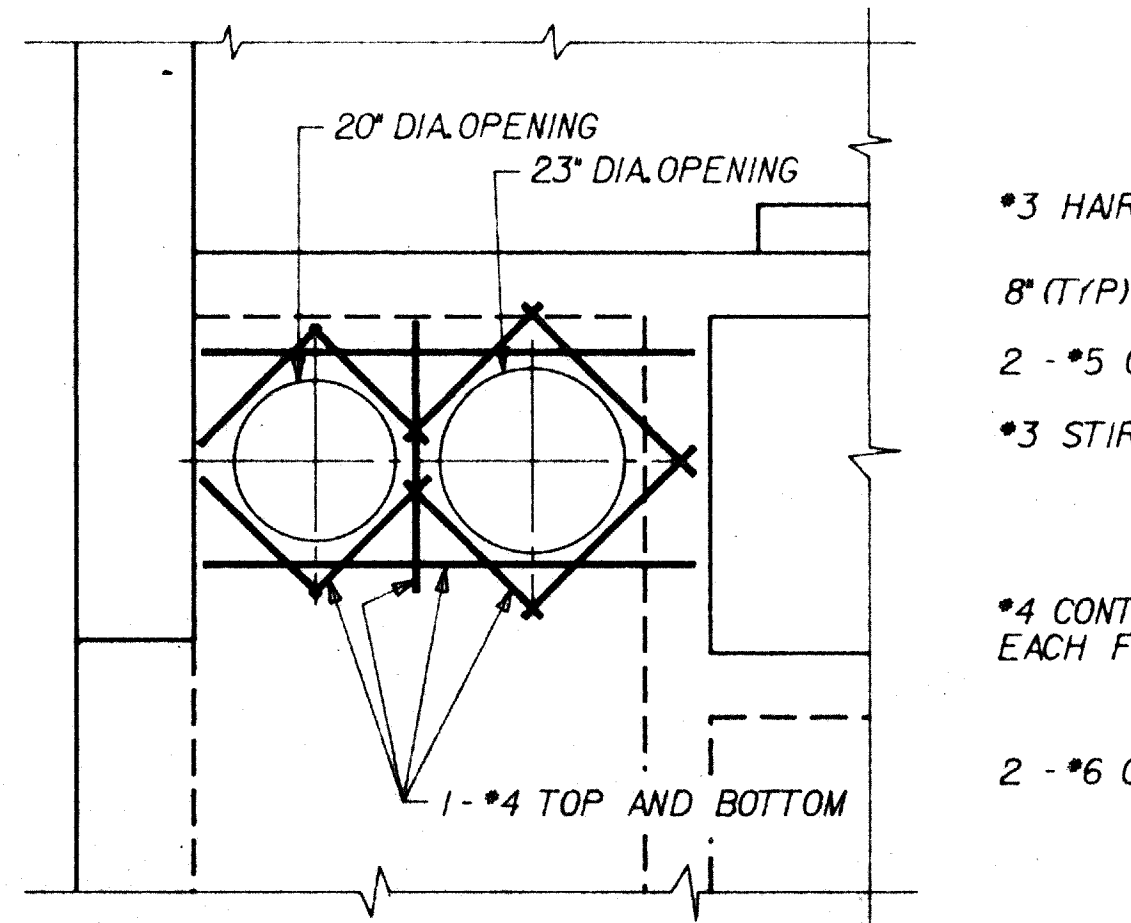

OPENING REINFORCING DETAIL

SCALE: 1/2" = 1'-0"

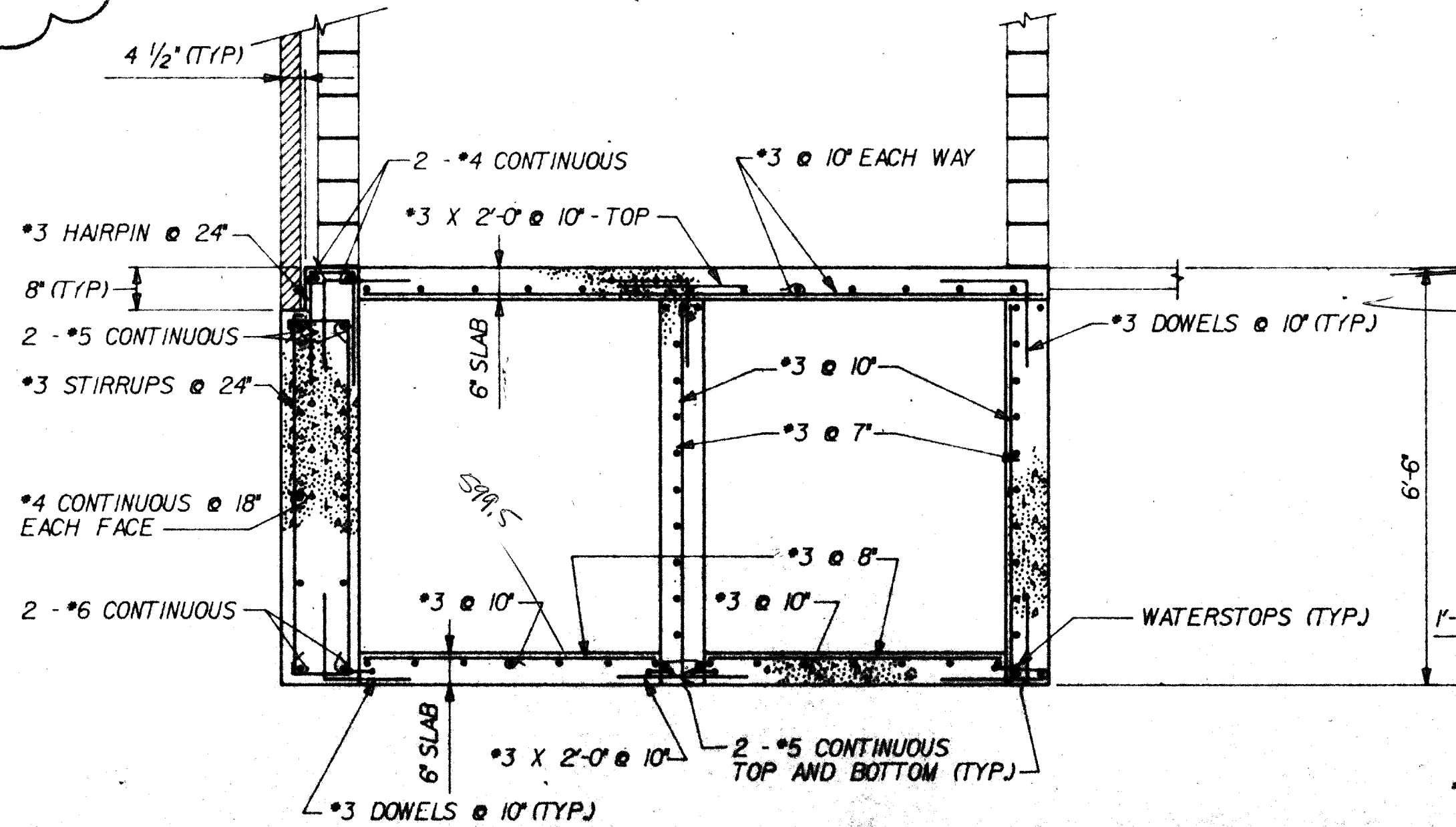

SECTION OF POOL SUMPS

SCALE: 1/2" = 1'-0"

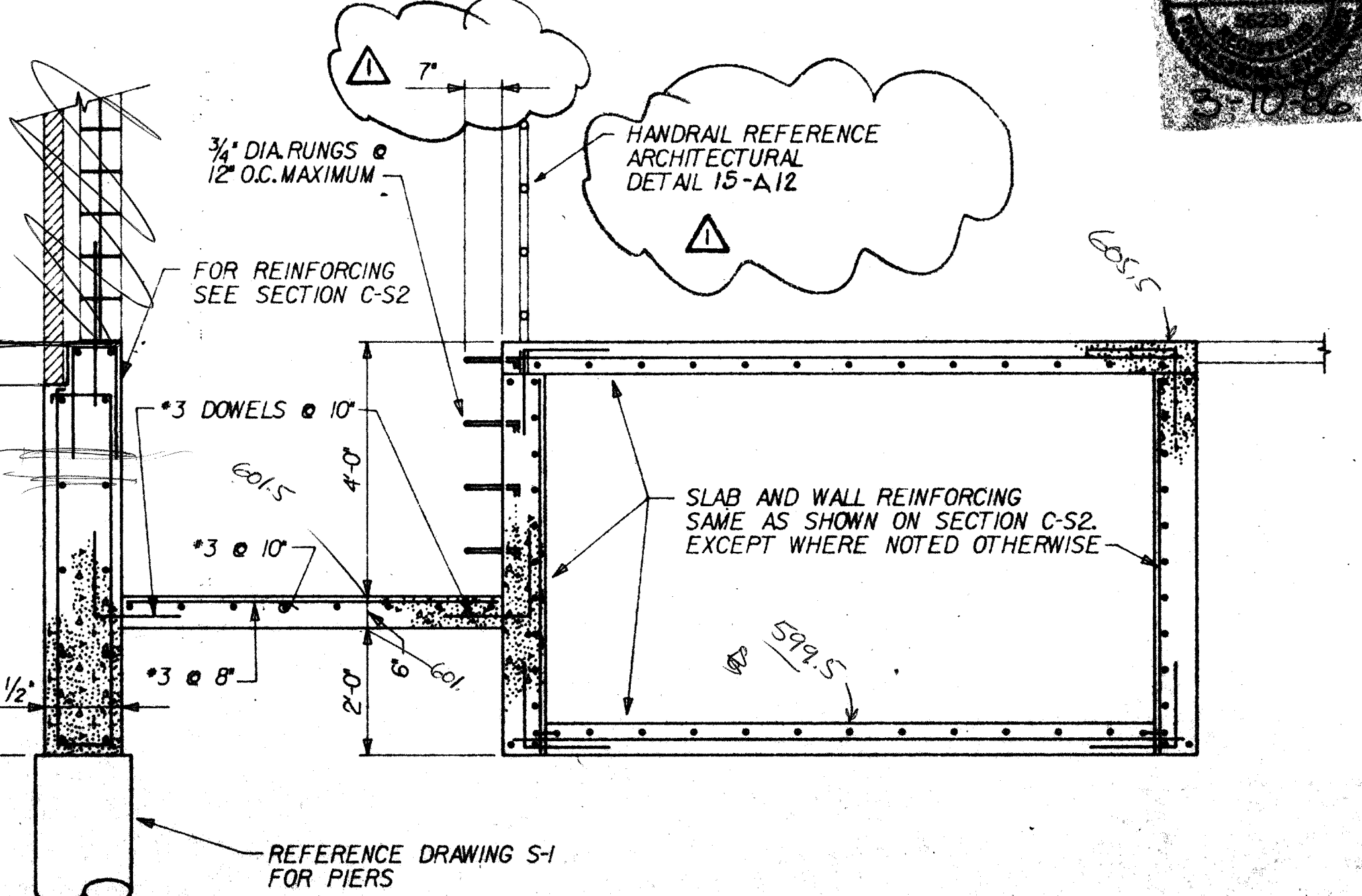

SECTION OF POOL SUMPS

SCALE: 1/2" = 1'-0"

The Benham Group Dallas

architects
engineers
planners
1341 w. mockingbird ln.
suite 517 e
dallas, texas

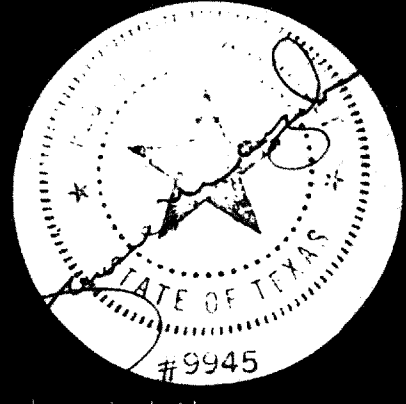

GROUND FLOOR SLAB PLAN

drawn by D. MESSNER
chk'd by E. KOCHICK
date 3-19-86
revisions

no. 1 date 4-21-86