

TOWN OF ADDISON, TEXAS

ORDINANCE NO. 011-001

AN ORDINANCE OF THE TOWN OF ADDISON, TEXAS AMENDING CHAPTER 62, SIGNS, OF THE CODE OF ORDINANCES OF THE TOWN BY ADDING AN ITEM G. (VITRUVIAN PARK) TO SECTION 62-289 (GENERALLY) OF ARTICLE VI. (SPECIAL DISTRICTS); PROVIDING A SAVINGS CLAUSE; PROVIDING A PENALTY NOT TO EXCEED THE SUM OF FIVE HUNDRED DOLLARS FOR ANY OFFENSE, AND A SEPARATE OFFENSE SHALL BE DEEMED COMMITTED EACH DAY DURING OR ON WHICH A VIOLATION OCCURS OR CONTINUES; PROVIDING A SEVERABILITY CLAUSE; PROVIDING AN EFFECTIVE DATE.

WHEREAS, the Town of Addison, Texas (the “City”) desires to amend certain provisions of Chapter 62 of the City’s Code of Ordinances relating to and regarding signs within the City; and

WHEREAS, the amendments set forth in this Ordinance to Chapter 62 are pursuant to investigation and analysis by the City, and are with a view of and to further the purposes and objectives set forth in Section 62-2 of the Code, including to promote the health, safety, welfare, convenience and enjoyment of the public, including among other things to promote the efficient transfer of information in sign messages and to protect the public welfare and to enhance the appearance and economic value of the landscape, and such amendments are to facilitate the avoidance of visual clutter that is potentially harmful to traffic and pedestrian safety, property values, business opportunities, and community appearance, and are to comply with applicable State law; and

WHEREAS, the City is authorized to provide for regulation of signs pursuant to State law, including, among others, Section 51.001, Tex. Loc. Gov. Code (authorizing a municipality to adopt an ordinance, rule or police regulation that is for the good government, peace, or order of the municipality or for the trade and commerce of the municipality) and Section 216.901 Tex. Loc. Gov. Code (authorizing a home rule municipality to license, regulate, control or prohibit the erection of signs or billboards), and pursuant to its authority as a home rule city under Article 11, Section 5 of the Texas Constitution and its Home Rule Charter; and

WHEREAS, the adoption of this Ordinance and the amendments set forth herein are for and in the best interests of the health, safety and welfare of the City and its citizens.

NOW, THEREFORE, BE IT ORDAINED BY THE CITY COUNCIL OF THE TOWN OF ADDISON, TEXAS:

Section 1. Incorporation of Recitals. The above and foregoing recitals and premises to this Ordinance are true and correct and are incorporated herein and made a part hereof for all purposes.

Section 2. Amendment. The Code of Ordinances of the Town of Addison, Texas (the "City") is hereby amended by amending certain sections and provisions of Chapter 62, Signs, thereof as set forth in Exhibit A attached hereto and incorporated herein for all purposes, and all other chapters, articles, sections, subsections, sentences, phrases and words of the said Code of Ordinances are not amended hereby.

Section 3. Savings; Repealer. This Ordinance shall be cumulative of all other ordinances of the City and shall not repeal any of the provisions of those ordinances except in those instances where the provisions of those ordinances are in direct conflict with the provisions of this Ordinance. Provided, however, that the repeal of such ordinances or parts of such ordinances, and the amendments and changes made by this Ordinance, shall not affect any right, property or claim which was or is vested in the City, or any act done, or right accruing or accrued, or established, or any suit, action or proceeding had or commenced before the time when this Ordinance shall take effect; nor shall said repeals, amendments or changes affect any offense committed, or any penalty or forfeiture incurred, or any suit or prosecution pending at the time when this Ordinance shall take effect under any of the ordinances or sections thereof so repealed, amended or changed; and to that extent and for that purpose the provisions of such ordinances or parts of such ordinances shall be deemed to remain and continue in full force and effect.

Section 4. Penalty. It shall be unlawful for any person, firm, corporation, or other business entity to violate any provision of this Ordinance, and any person, firm, corporation, or other business entity violating or failing to comply with any provision hereof shall be fined, upon conviction, in an amount of not more than Five Hundred and No/100 Dollars (\$500.00), and a separate offense shall be deemed committed each day during or on which a violation or failure occurs or continues.

Section 5. Severability. The provisions of this Ordinance are severable, and if any section or provision of this Ordinance or the application of any section or provision to any person, firm, corporation, entity, situation or circumstance is for any reason adjudged invalid or held unconstitutional by a court of competent jurisdiction, the same shall not affect the validity of any other section or provision of this Ordinance or the application of any other section or provision to any other person, firm, corporation, entity, situation or circumstance, and the City Council declares that it would have adopted the valid portions of this Ordinance adopted herein without the invalid or unconstitutional parts and to this end the provisions of this Ordinance adopted herein shall remain in full force and effect.

Section 6. Effective Date. This Ordinance shall become effective from and after its passage and approval and its publication as may be required by law (including, without limitation, the City Charter and the ordinances of the City).

PASSED AND APPROVED by the City Council of the Town of Addison, Texas this 11th day of January 2011.

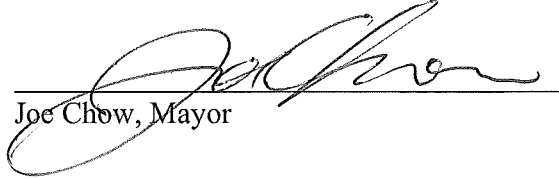

Joe Chow, Mayor

ATTEST:

By: 

Lea Dunn, City Secretary

APPROVED AS TO FORM:

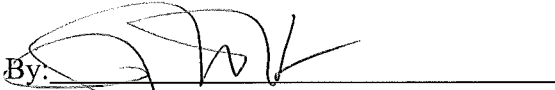
By: 

John Hill, City Attorney

Published: _____

**EXHIBIT A
TO ORDINANCE NO. 011-001**

Chapter 62, Signs, of the Code of Ordinances (the "Code") of the Town of Addison, Texas is hereby amended by amending various sections of the said Code as set forth below and as follows (additions are underlined; deletions are):

- A. Section 62-289 of the Code is amended by adding item G. to read as follows:

ARTICLE VI. SPECIAL DISTRICTS

Section 62-289 Generally

- G. Vitruvian Park (being that area shown in Fig. 62-289.6)

STANDARDS FOR SIGNS

1. Attached Commercial Tenant identification Sign:
 - (a) Each commercial tenant may have one sign per 50 lineal feet of building frontage, with a maximum of two signs spaced a minimum of 25' apart.
 - (b) The sign area is limited to one square foot of sign per lineal foot of building frontage up to a maximum of 200 square feet of total sign area with no individual sign exceeding 100 square feet in area.
 - (c) The sign may project more than 18" from the building façade.
 - (d) Signs projecting more than 18" from the building façade shall be located a minimum of 8' above grade.
 - (e) Signs shall be placed on exterior facades common with the tenant space.

2. Attached Commercial Blade Signs:
 - (a) Each commercial tenant may have a blade sign in addition to a tenant identification sign.
 - (b) Each commercial tenant may have one sign per 50 lineal feet of building frontage, with a maximum of two signs spaced a minimum of 25' apart.
 - (c) The maximum projection from the building façade shall not exceed 4'.
 - (d) The minimum height above the sidewalk shall not be less than 8'.
 - (e) The maximum height above the sidewalk shall not exceed 10'.
 - (f) The sign shall not exceed 6 square feet in area.
 - (g) The signs shall be placed on exterior facades common with the tenant space.

3. Portable signs do not need a permit but shall comply with the following:
 - (a) Each commercial tenant shall be allowed not more than one portable sign, which shall be located within the public sidewalk adjacent to the occupancy.

- (b) A minimum of four feet of clear sidewalk shall be maintained at all times.
- (c) Signs shall be constructed as shown in Figure 62-289.3B.

4. The monument sign shall comply with the following:

- (a) Shall be constructed as shown in Figure 62-289.7.
- (b) Shall be placed as shown in Figure 62-289.8.

5. Pole signs shall comply with the following:

- (a) Shall be constructed as shown in Figure 62-289.9.
- (b) Shall only be of a seasonal or decorative type.
- (c) Shall not contain any adverting or promotional messages related to Vitruvian Park.

FIGURE 62-289.6

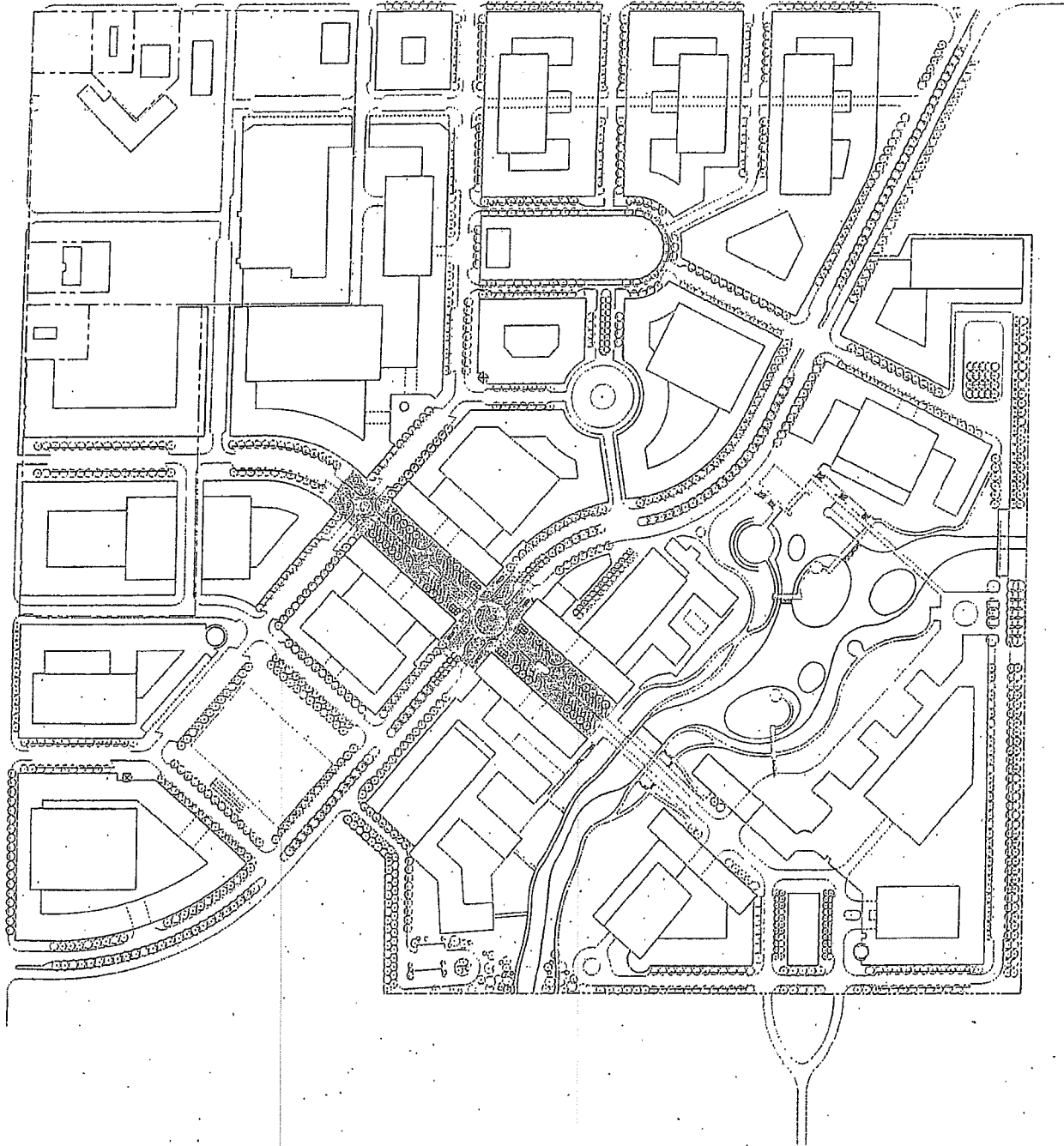

VITRUVIAN PARK

MASTER PLAN

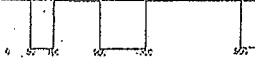

KEVIN
STOVIN
STUDIO

FIGURE 6Z-Z89.7

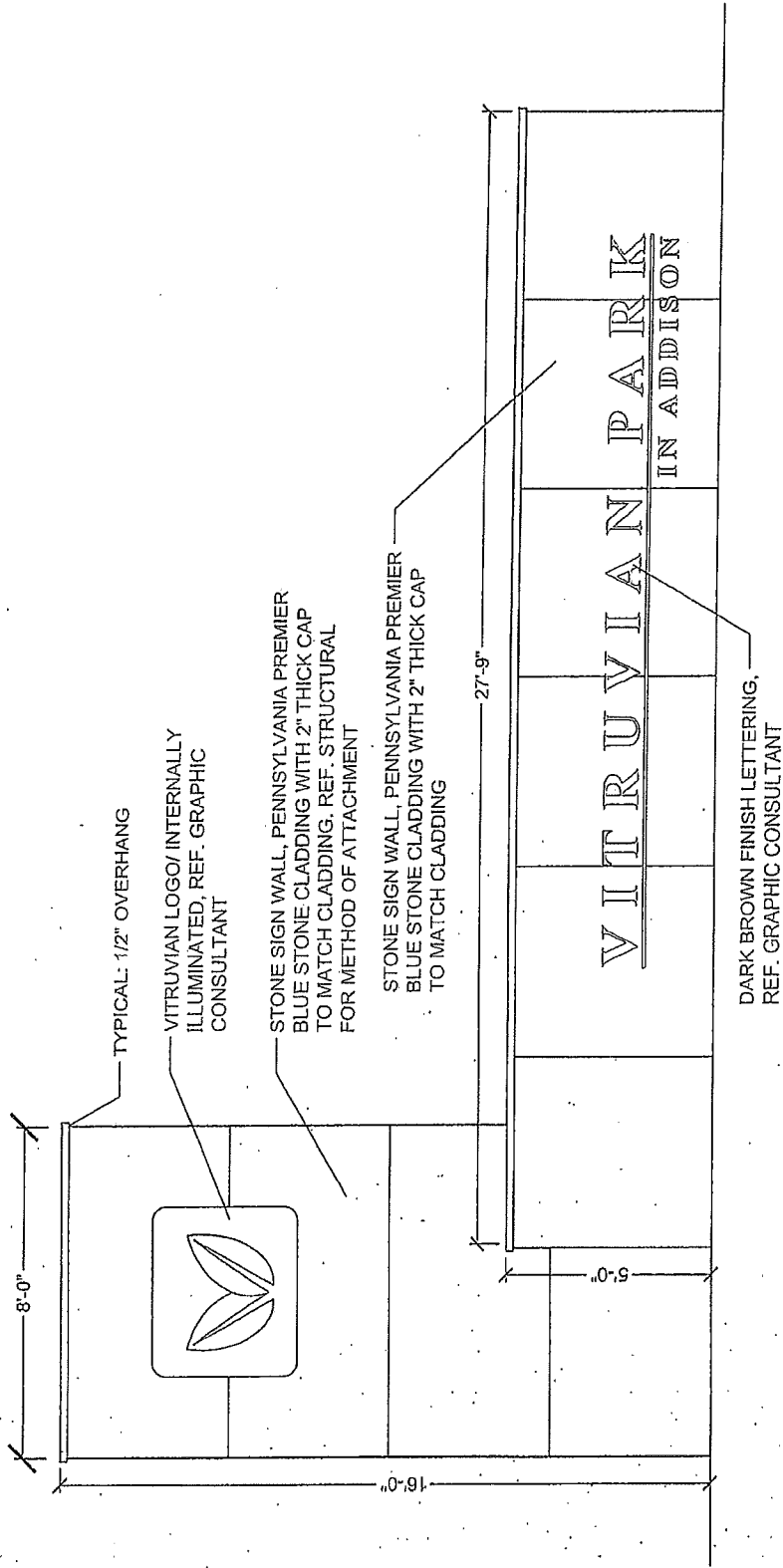

VITRUVIAN PARK
SPRING VALLEY SIGNAGE
ADDISON, TEXAS
SCALE: 3/4"=1'-0"

UDR

5430 LBJ FREEWAY, SUITE 1250
DALLAS, TX 75240
972.763.3510 PH/ 972.866.0163 F

LINDA TYCHER & ASSOCIATES, INC.
1111 N. CENTRAL EXPRESSWAY - SUITE 1100
DALLAS, TEXAS 75243
TEL: 972.555.1216

LINDA TYCHER & ASSOCIATES

VITRUVIAN PARK
Addison, TX

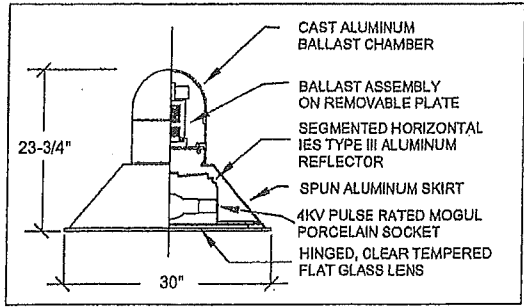

LUMINAIRE DETAILS

PD810292

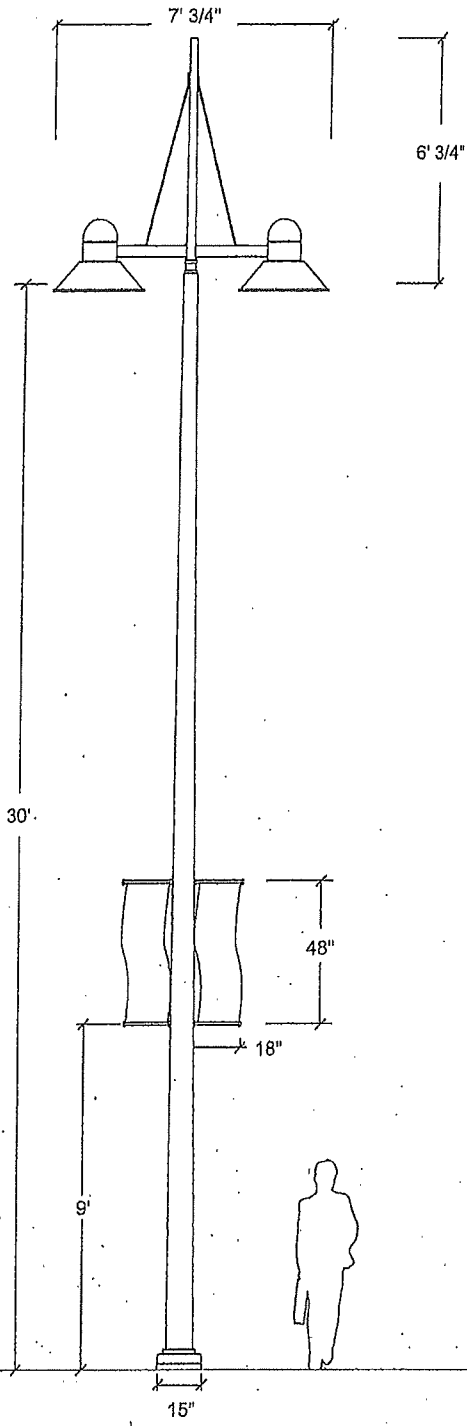

BOTTOM VIEW

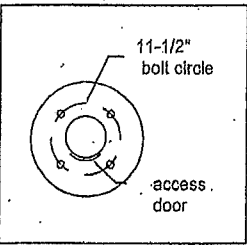

- Ballast chamber:** heavy wall cast aluminum
- Decorative skirt:** spun aluminum, permanently attached to the domed ballast chamber.
- Diffuser:** hinged, clear tempered flat glass
- Optics:** segmented horizontal bright anodized reflector IES type III with full cutoff
- Ballast:** pulse start 400W MH, ANSI M155, multi (quad) lap, wired for ____V, with tool-less access and quick disconnects, mounted on a removable plate within the luminaire.
- Socket size:** mogul, porcelain, 4KV pulse rated
- Lamp:** ED28 (by others)
- Arm:** aluminum 2" x 3" rectangular extrusion welded to an aluminum column, with aluminum support beams.
- Configuration:** twin
- Shaft:** round tapered steel, welded in and over a steel base plate.
- Base cover:** two-piece cast aluminum, attached to pole with tamper resistant s/s hardware.
- Anchor bolts:** four 36"L x 1"OD galvanized steel 55ksi min. yield bolts with 4" hook and 4" projection, with two nuts and two washers each and a steel template to install bolts on 11-1/2" bolt circle.
- Banner arms:** 1"OD x 18"L aluminum tubing threaded into steel hubs, which are welded onto the pole shaft. Comes with 2" cast aluminum removable half balls. Banners by others.
- All exposed hardware:** stainless steel
- Finish:** TGIC polyester powder coat
- Color:** silver

Date: Oct. 29, 2008
Model: (2) CSH3024-40M-VOLT-H3-CSA-B-SP25-MOD15-RTC-30-BAB-22-SLR

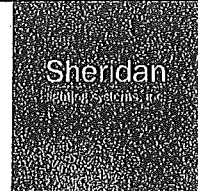

Sheridan Lighting Systems, Inc.
4-2525 Dunwin Dr
Mississauga, ON L5L 1R9
T 905-369-0101 F 905-369-0102
sales@sheridansys.com www.sheridansys.com

(C) 2008 Sheridan Lighting Systems, Inc. All rights reserved. Specifications subject to change without notice.

FIGURE 62-289.9