

**5** hollow metal jamb  
3/4" x 10"

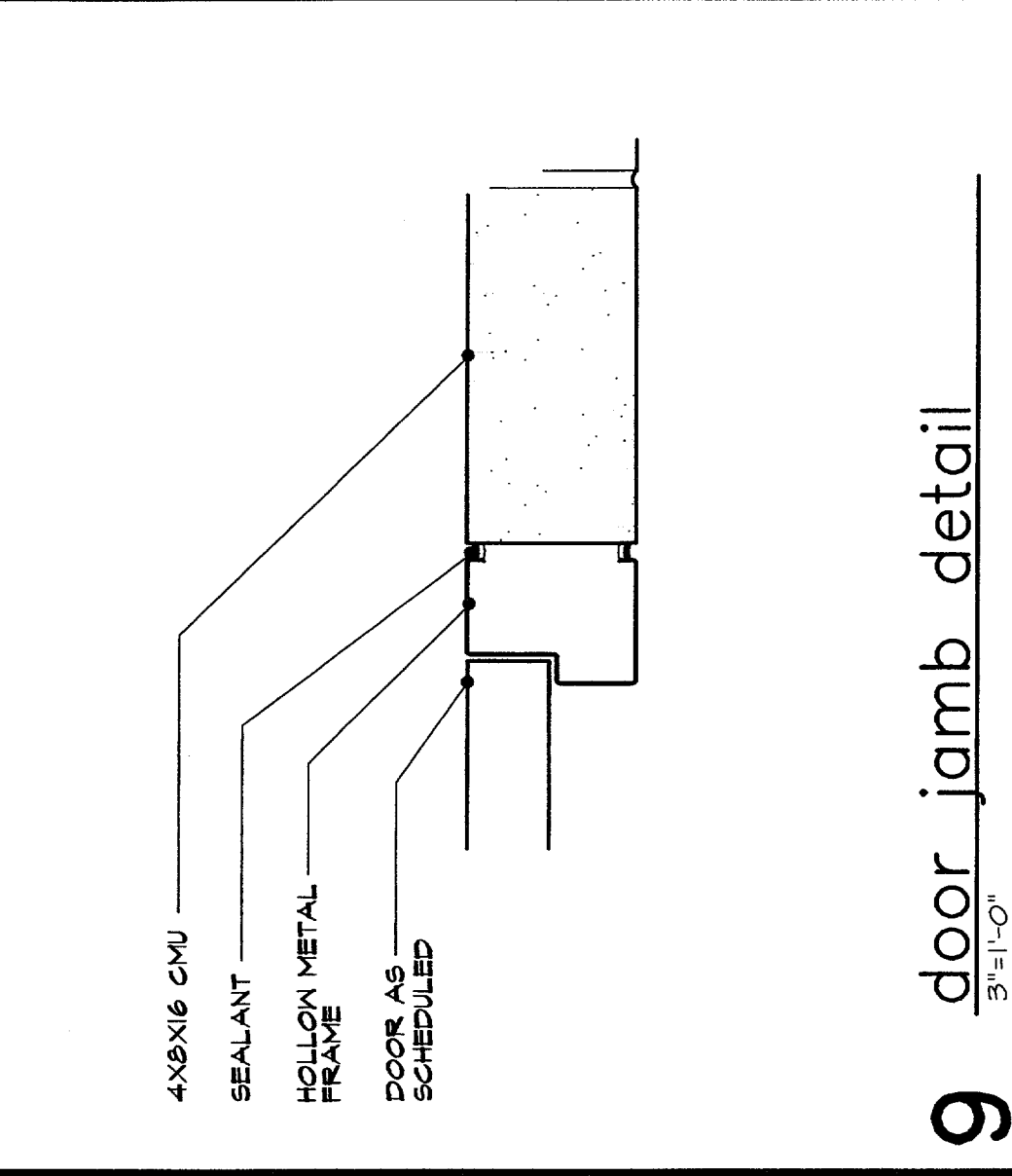

**9** door jamb detail  
3/4" x 10"

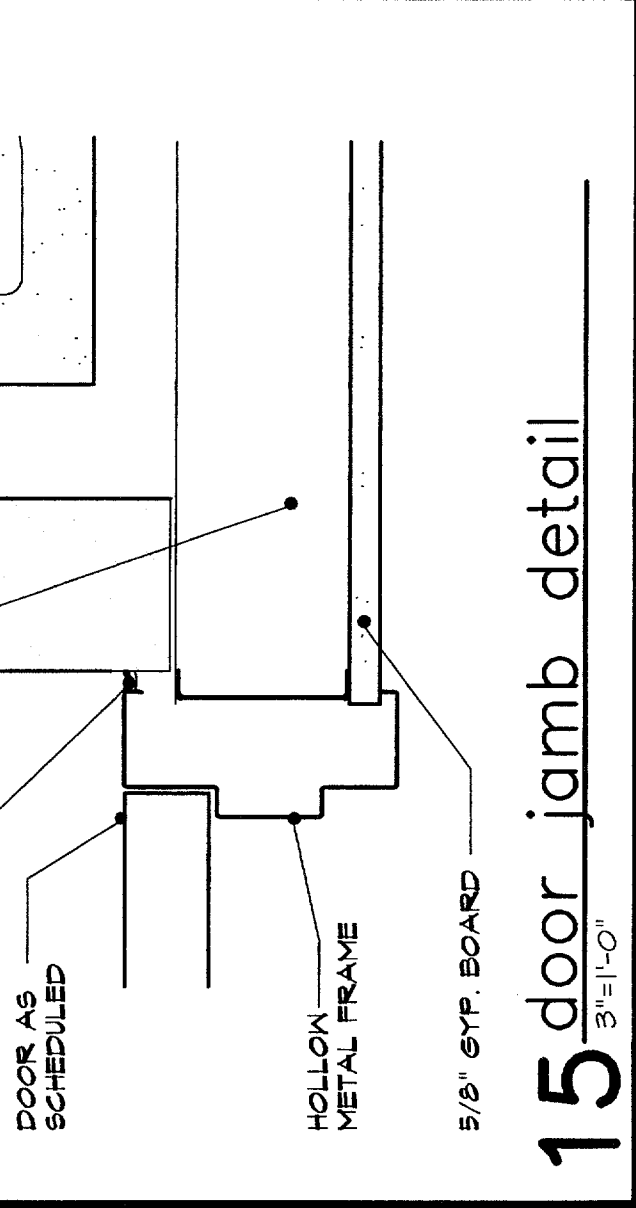

**15** door jamb detail  
3/4" x 10"

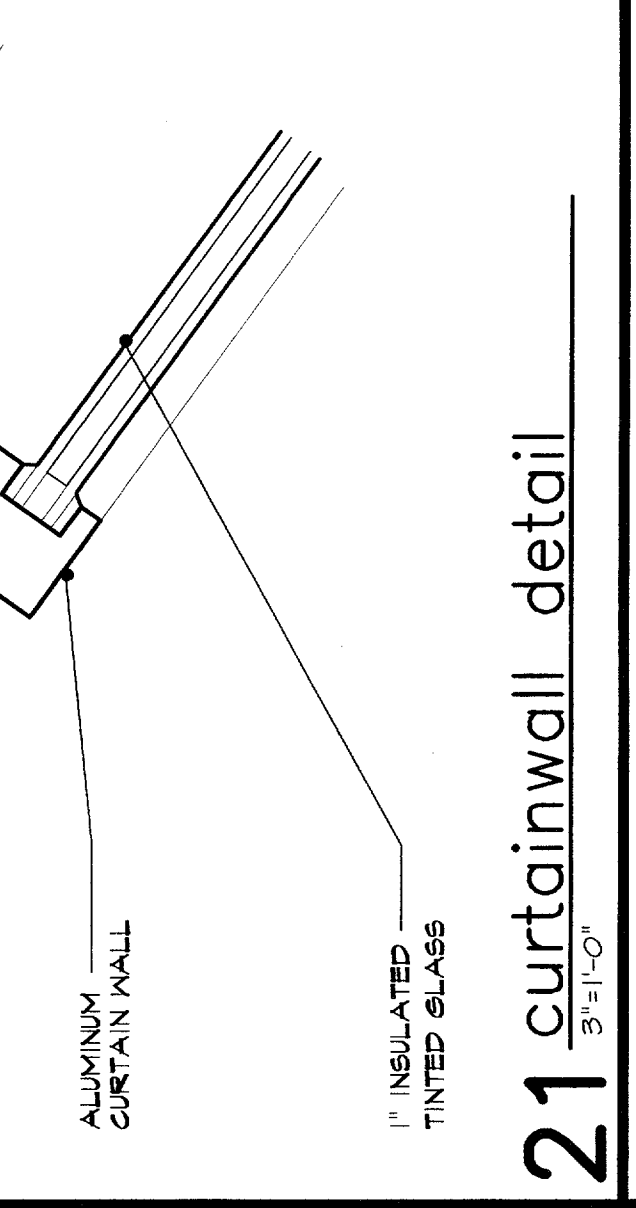

**21** curtainwall detail  
3/4" x 10"

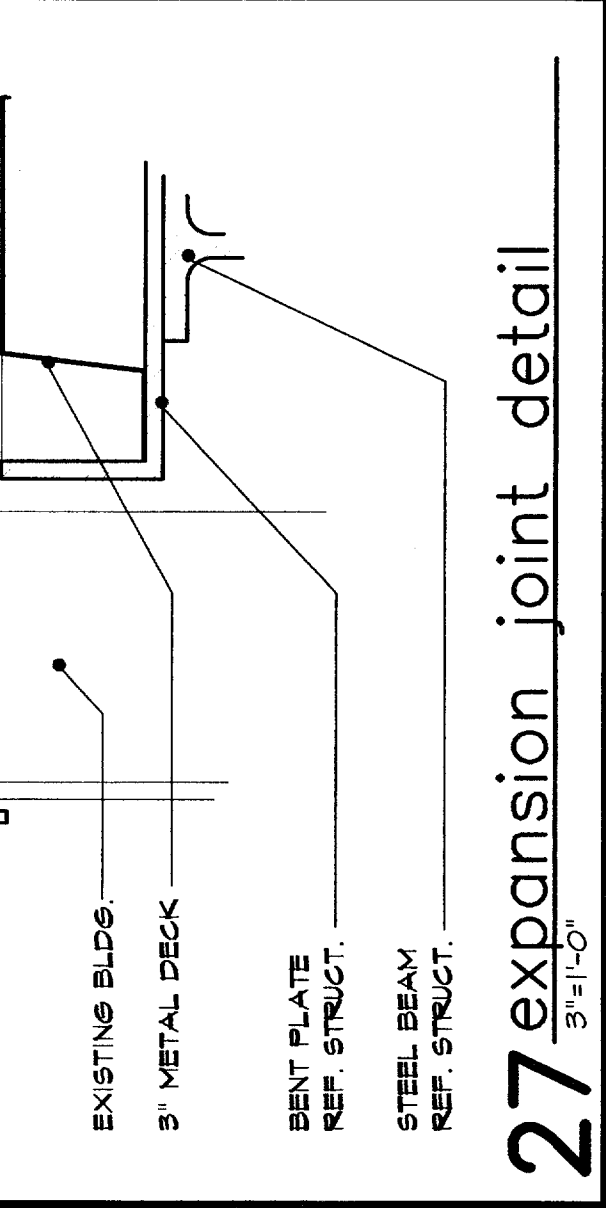

**27** expansion joint detail  
3/4" x 10"

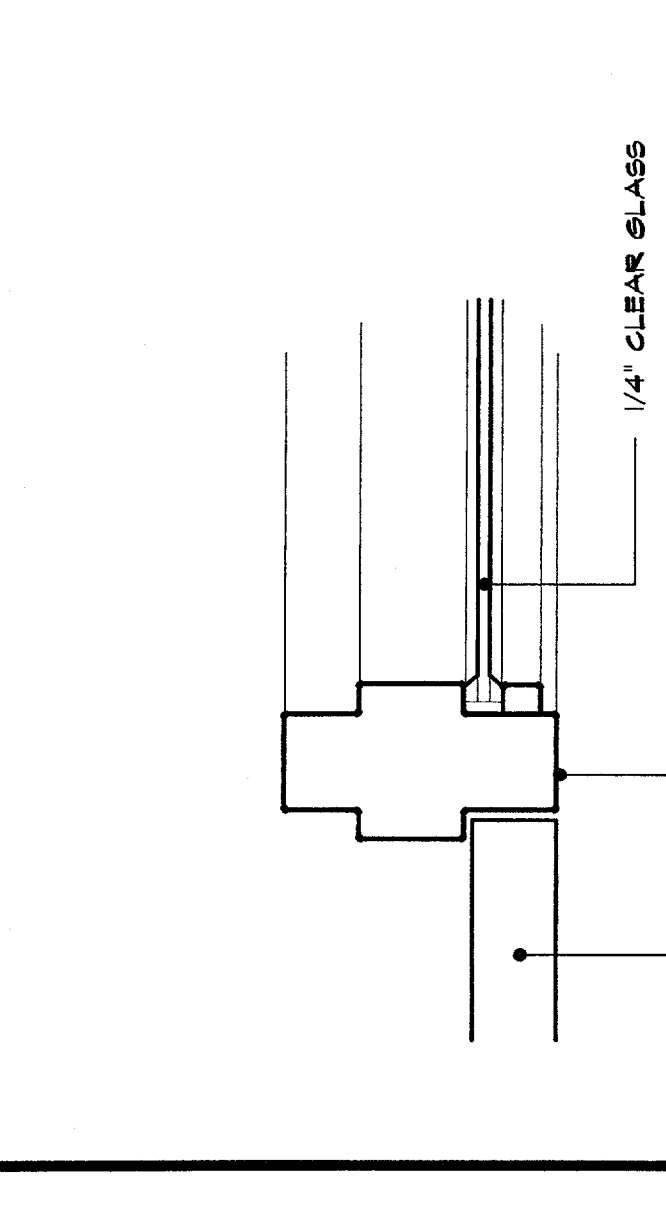

**4** door jamb detail  
3/4" x 10"

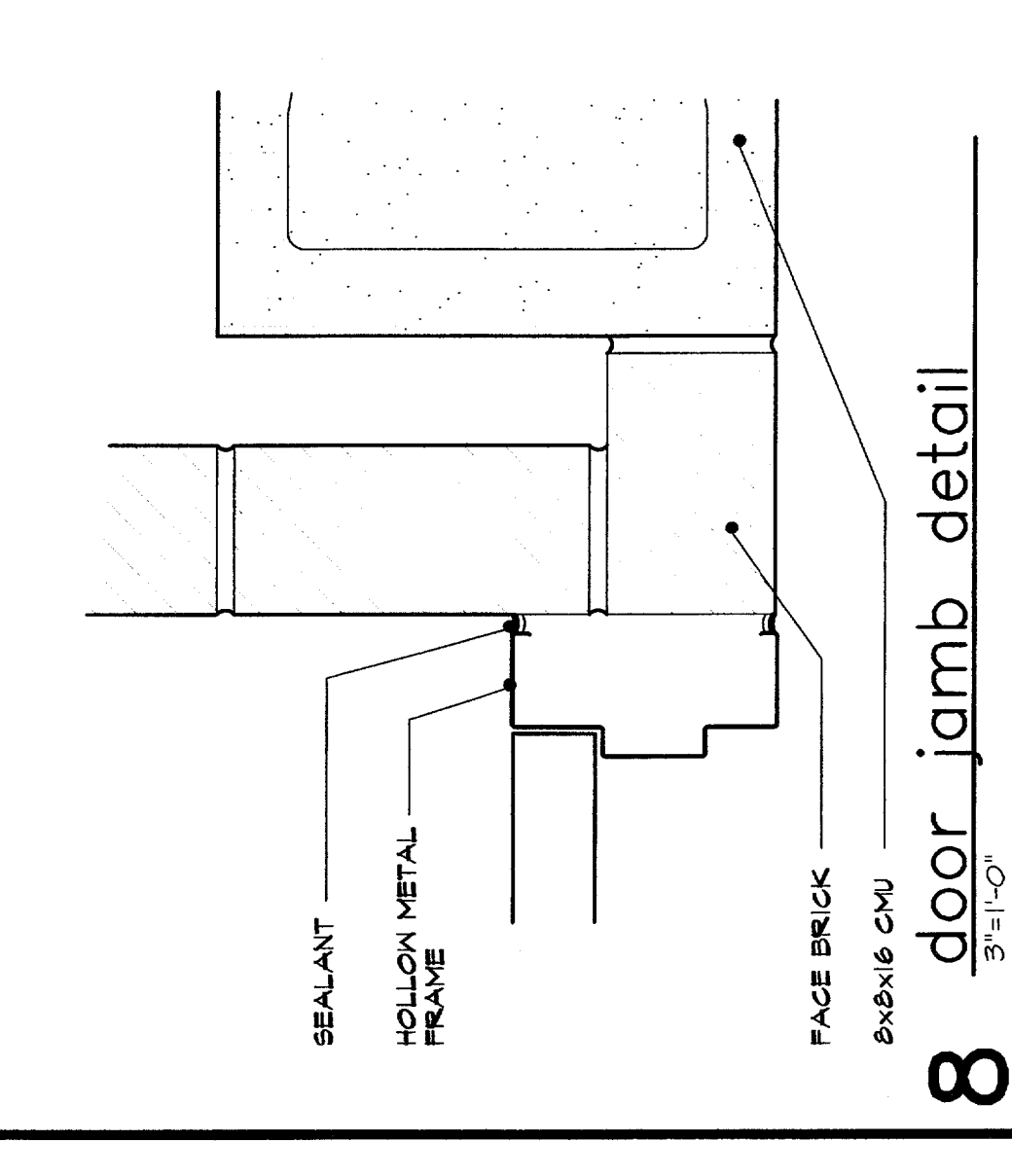

**8** door jamb detail  
3/4" x 10"

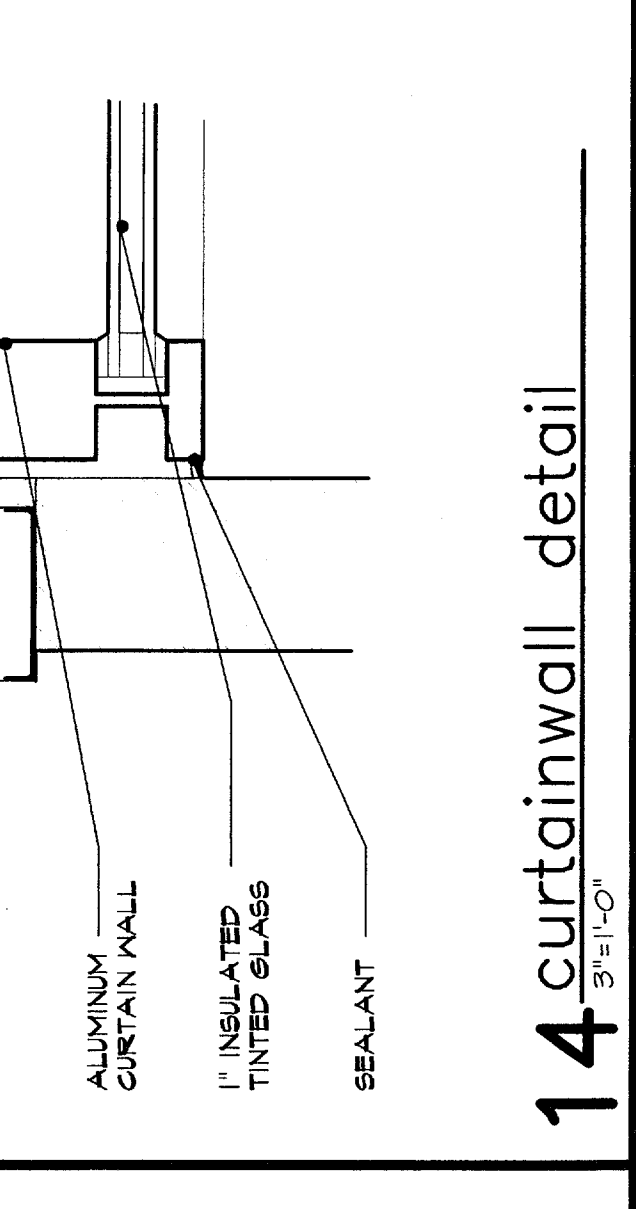

**14** curtainwall detail  
3/4" x 10"

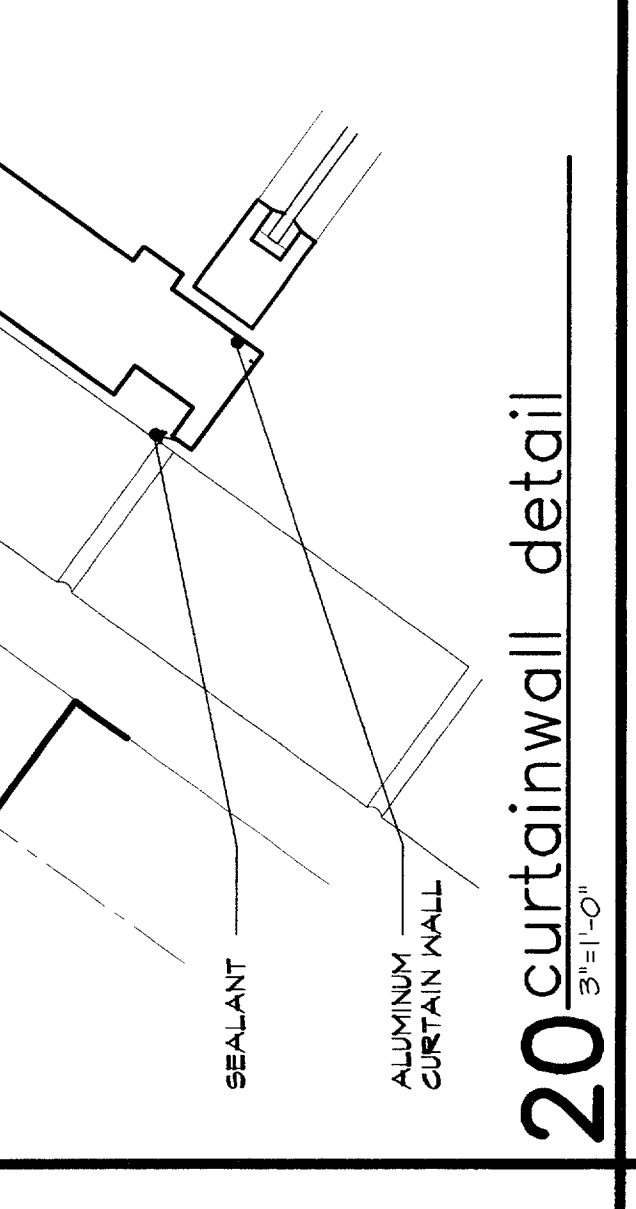

**20** curtainwall detail  
3/4" x 10"

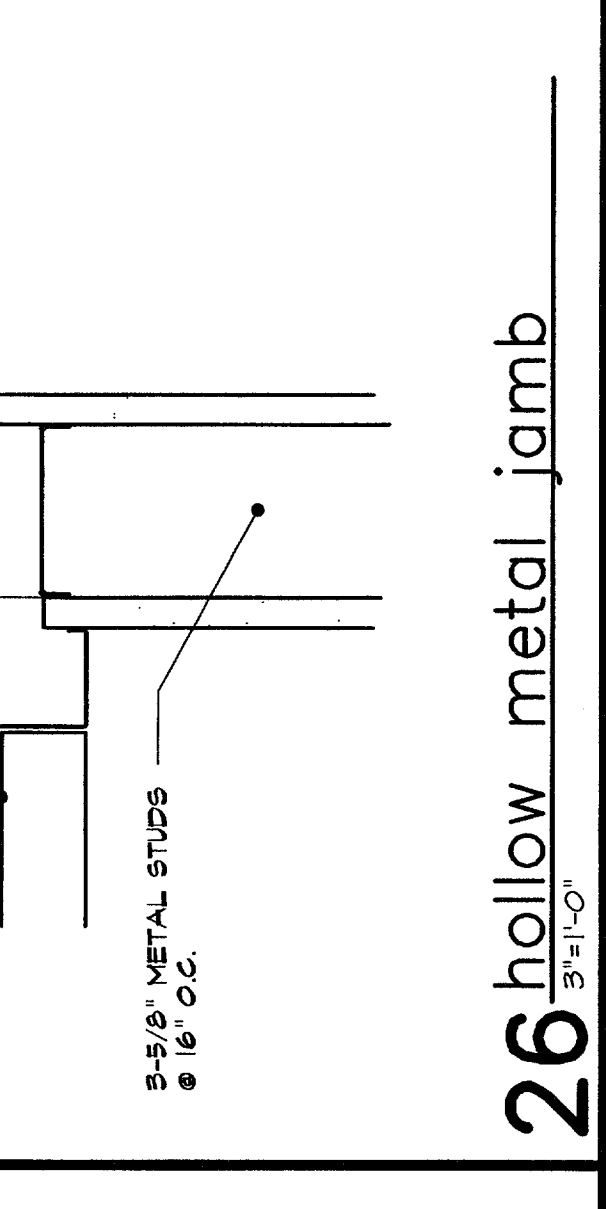

**26** hollow metal jamb  
3/4" x 10"

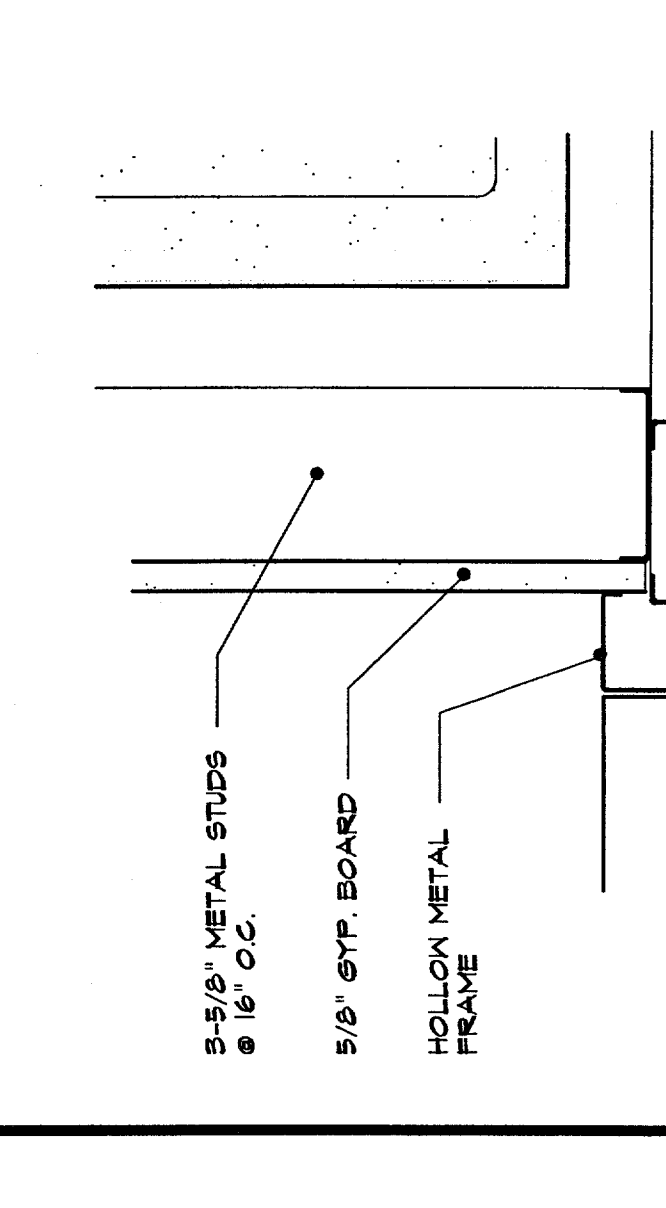

**3** door jamb detail  
3/4" x 10"

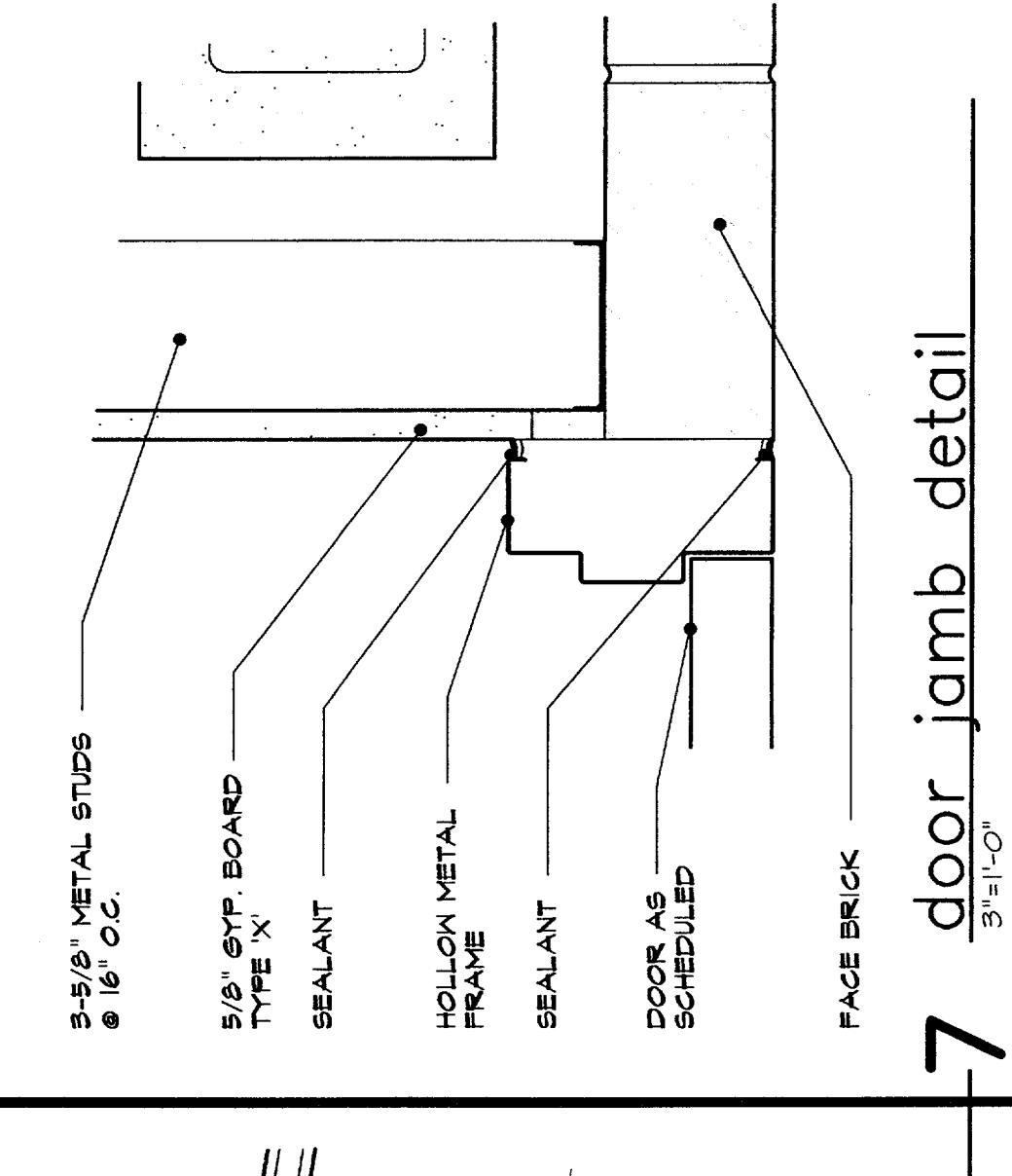

**7** door jamb detail  
3/4" x 10"

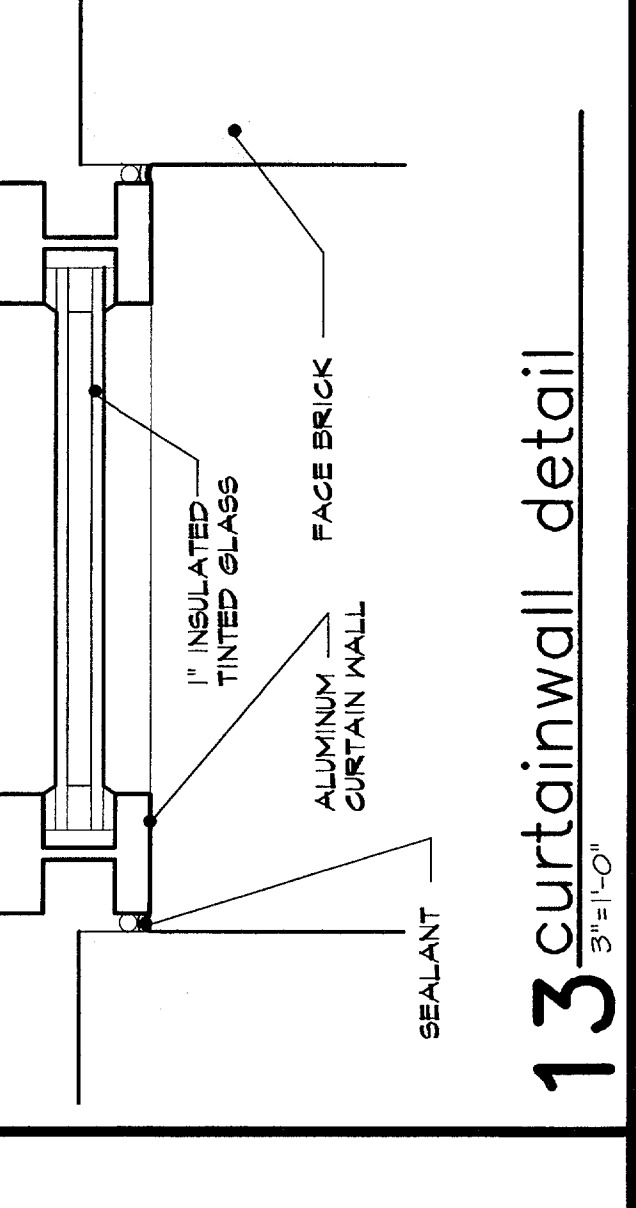

**13** curtainwall detail  
3/4" x 10"

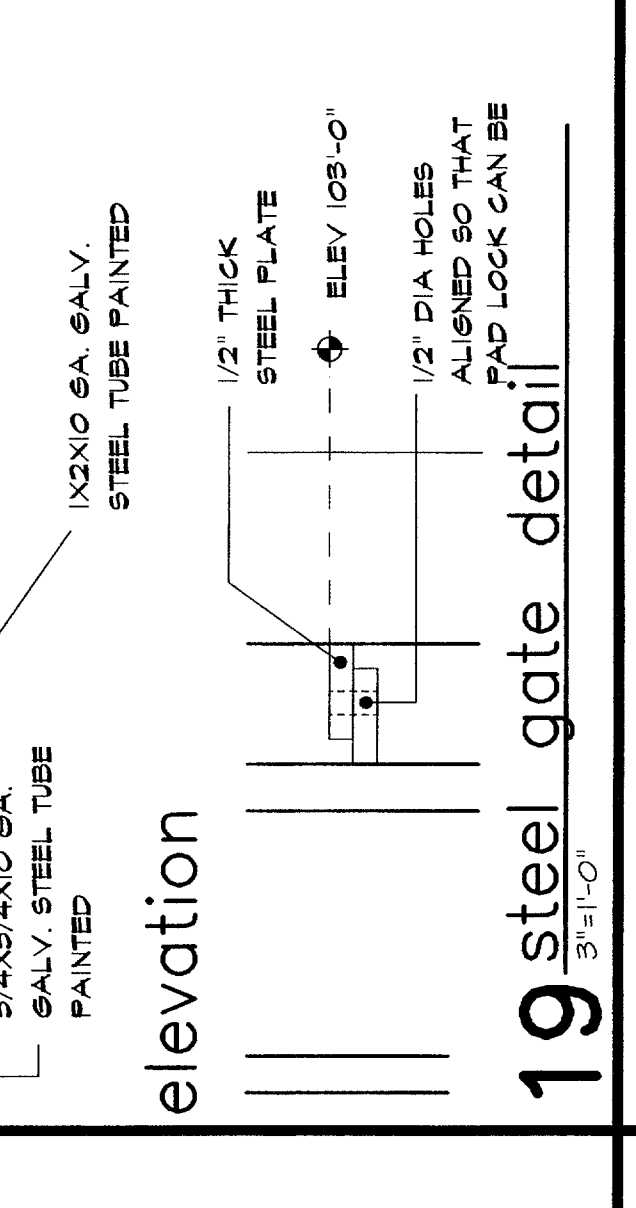

**19** steel gate detail  
3/4" x 10"

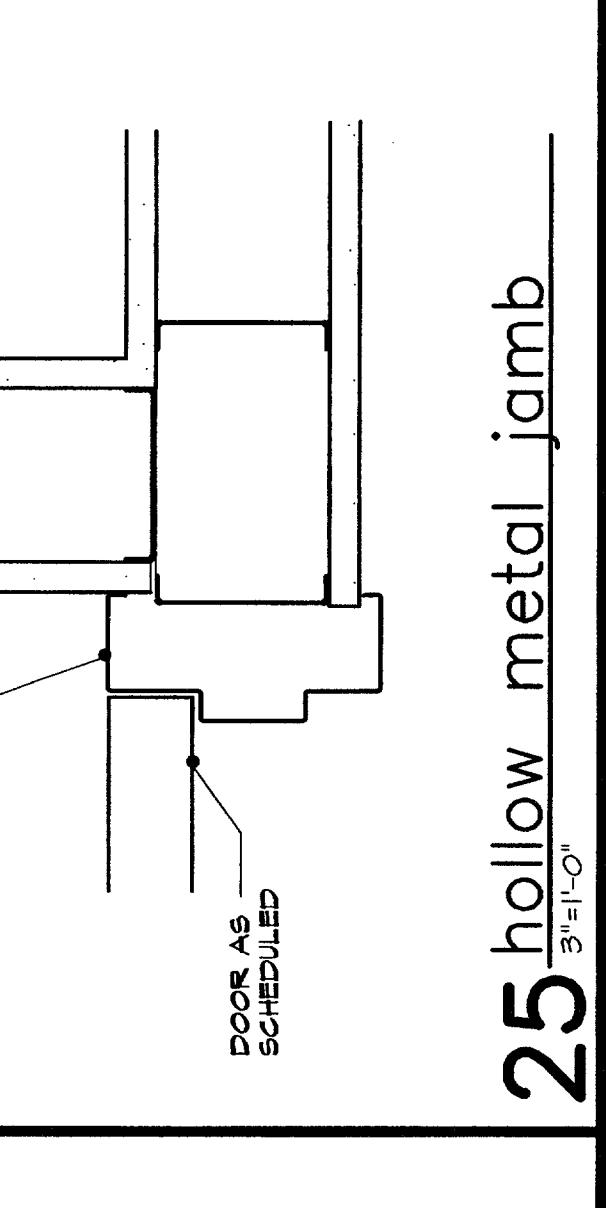

**25** hollow metal jamb  
3/4" x 10"

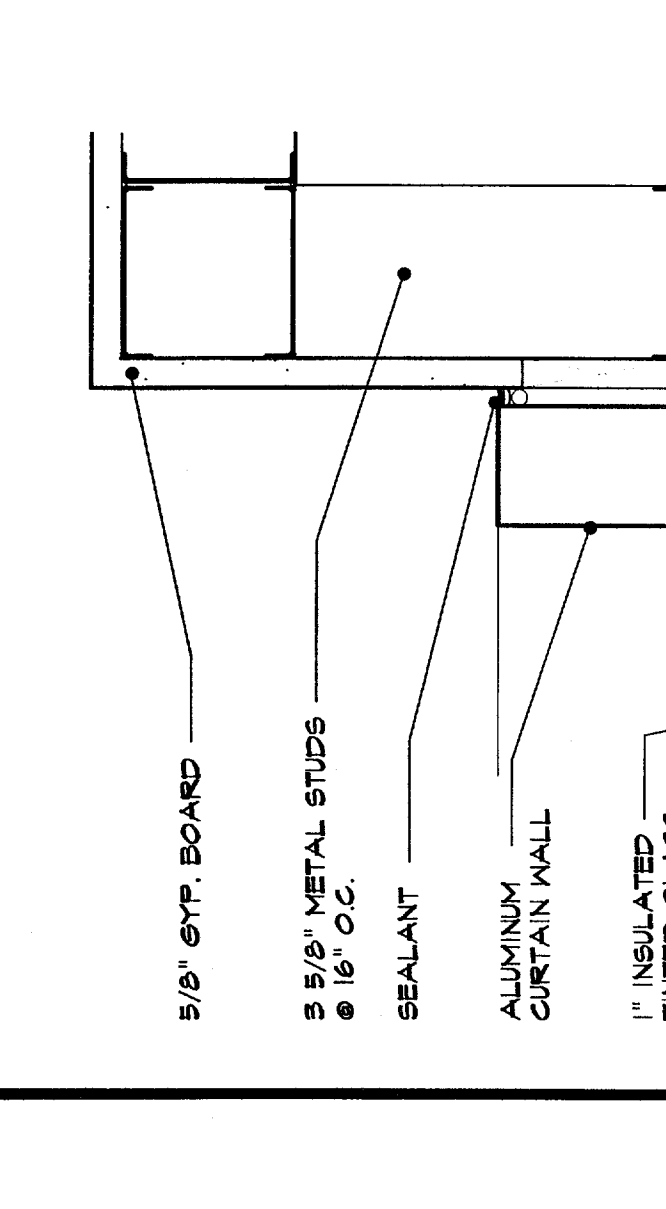

**2** curtainwall detail  
3/4" x 10"

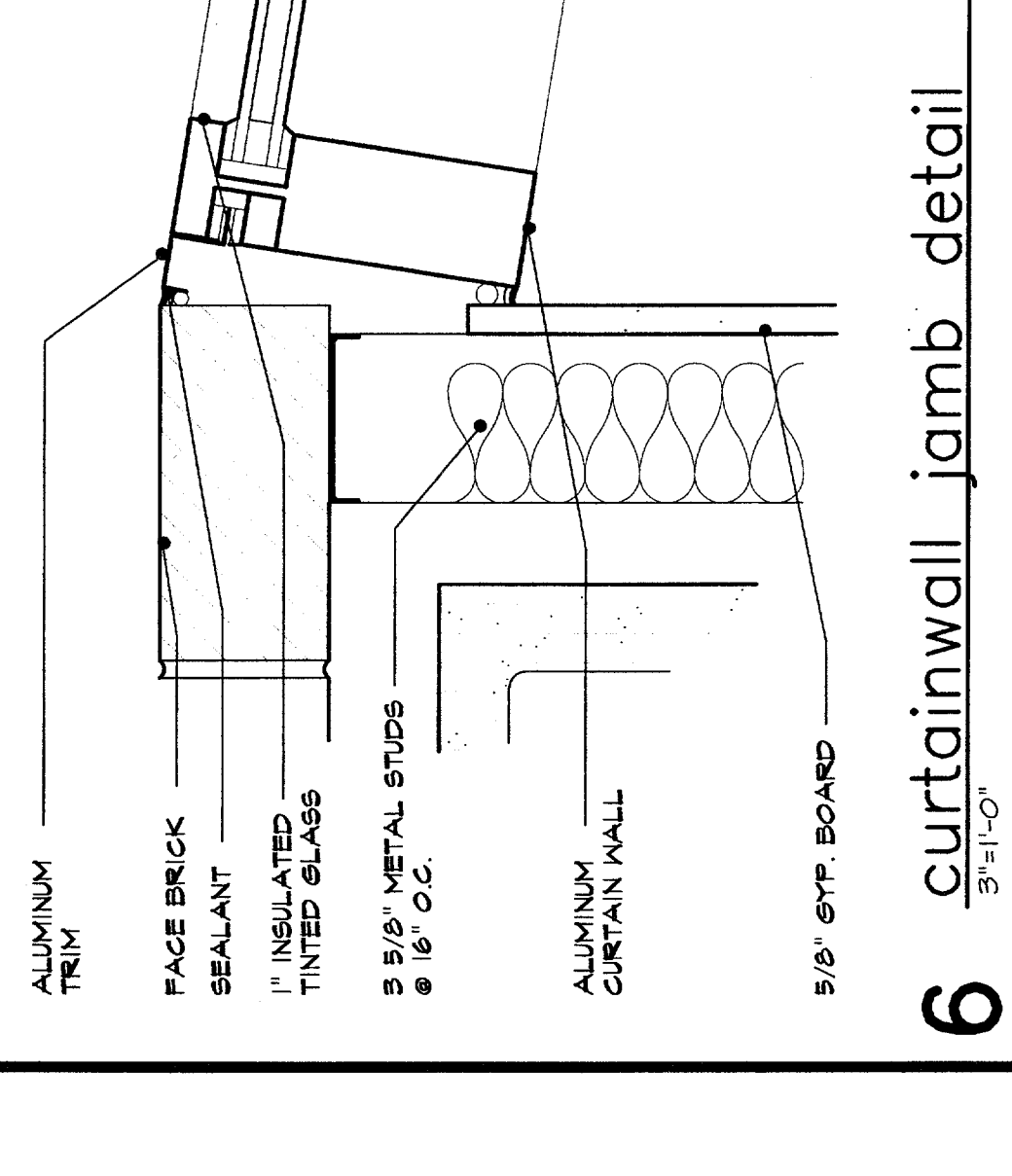

**6** curtainwall jamb detail  
3/4" x 10"

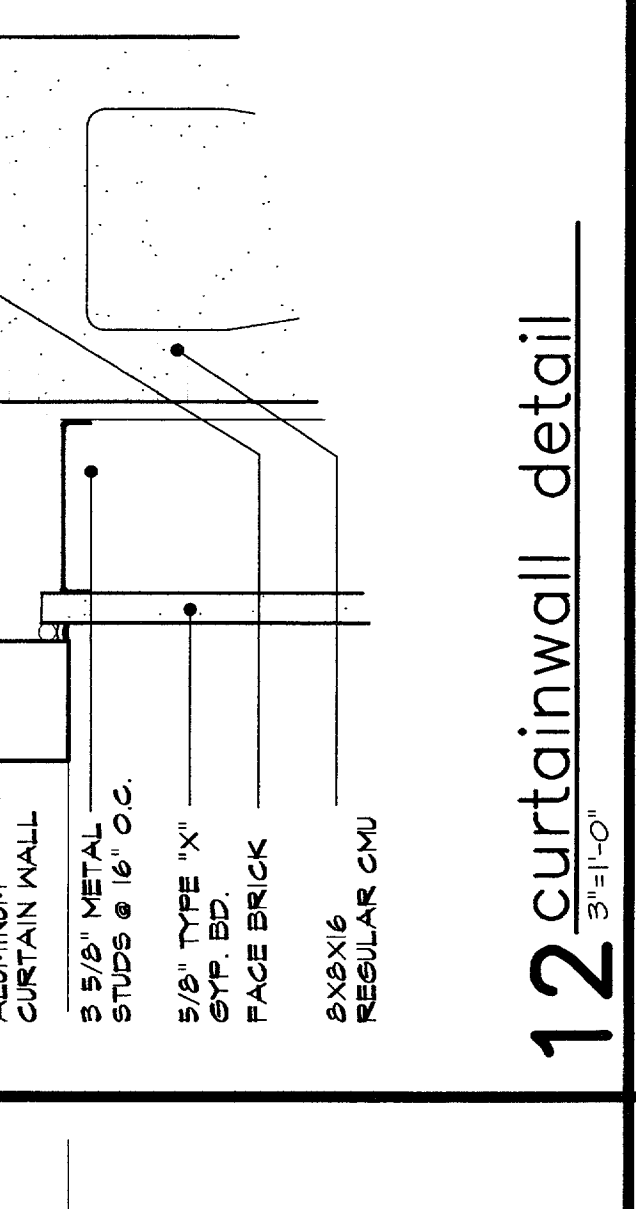

**12** curtainwall detail  
3/4" x 10"

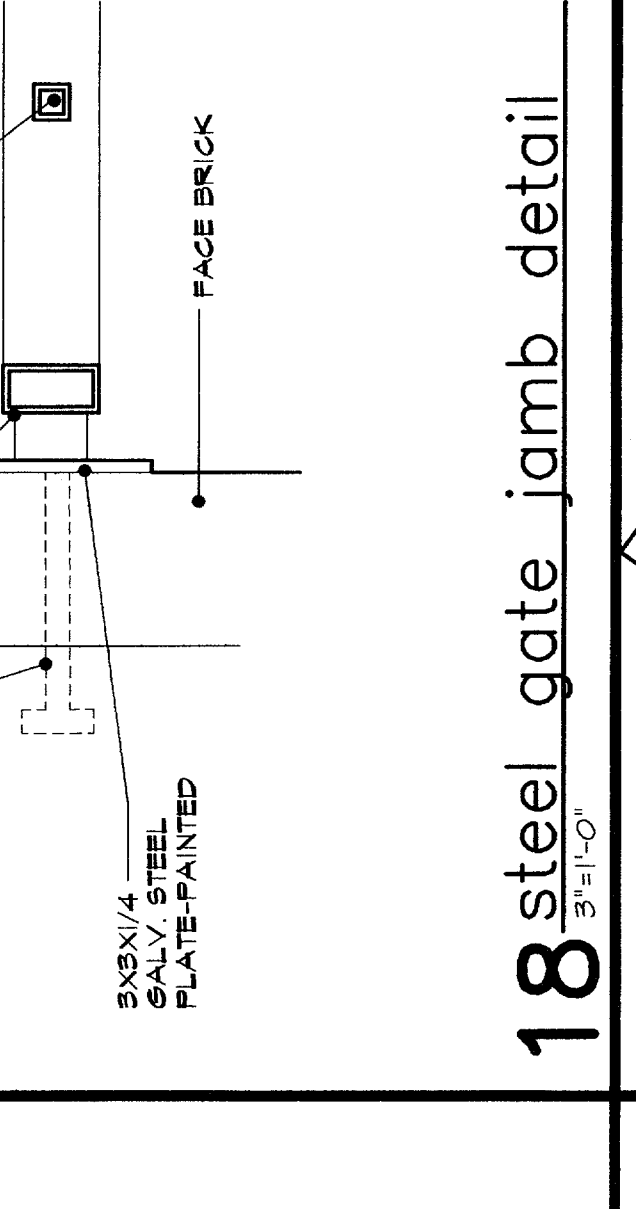

**18** steel gate jamb detail  
3/4" x 10"

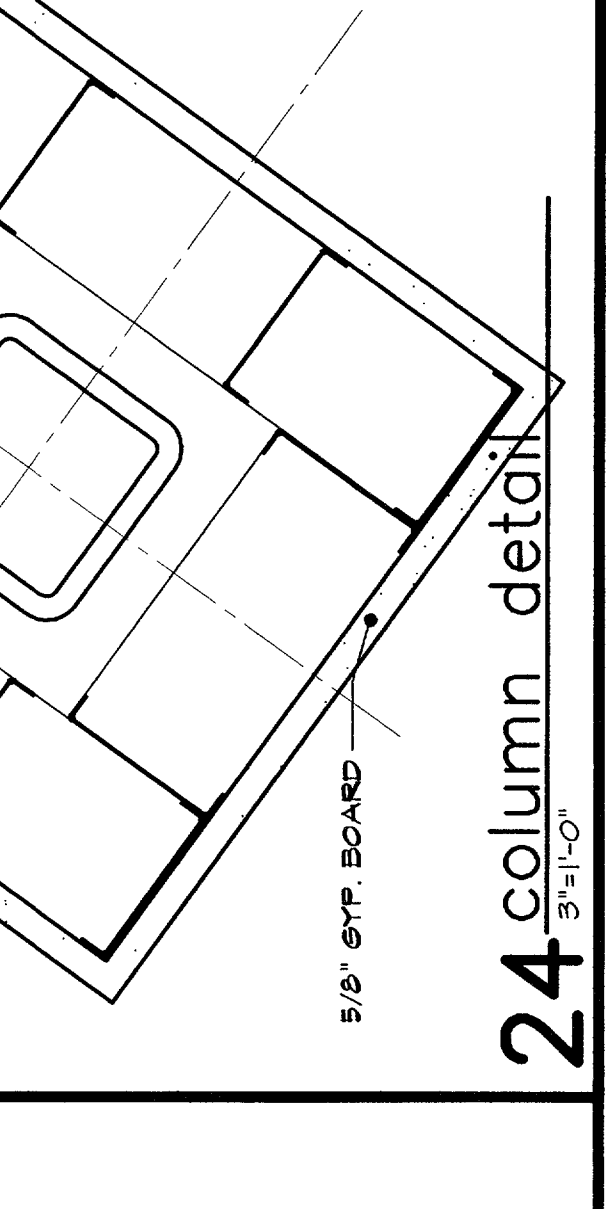

**24** column detail  
3/4" x 10"

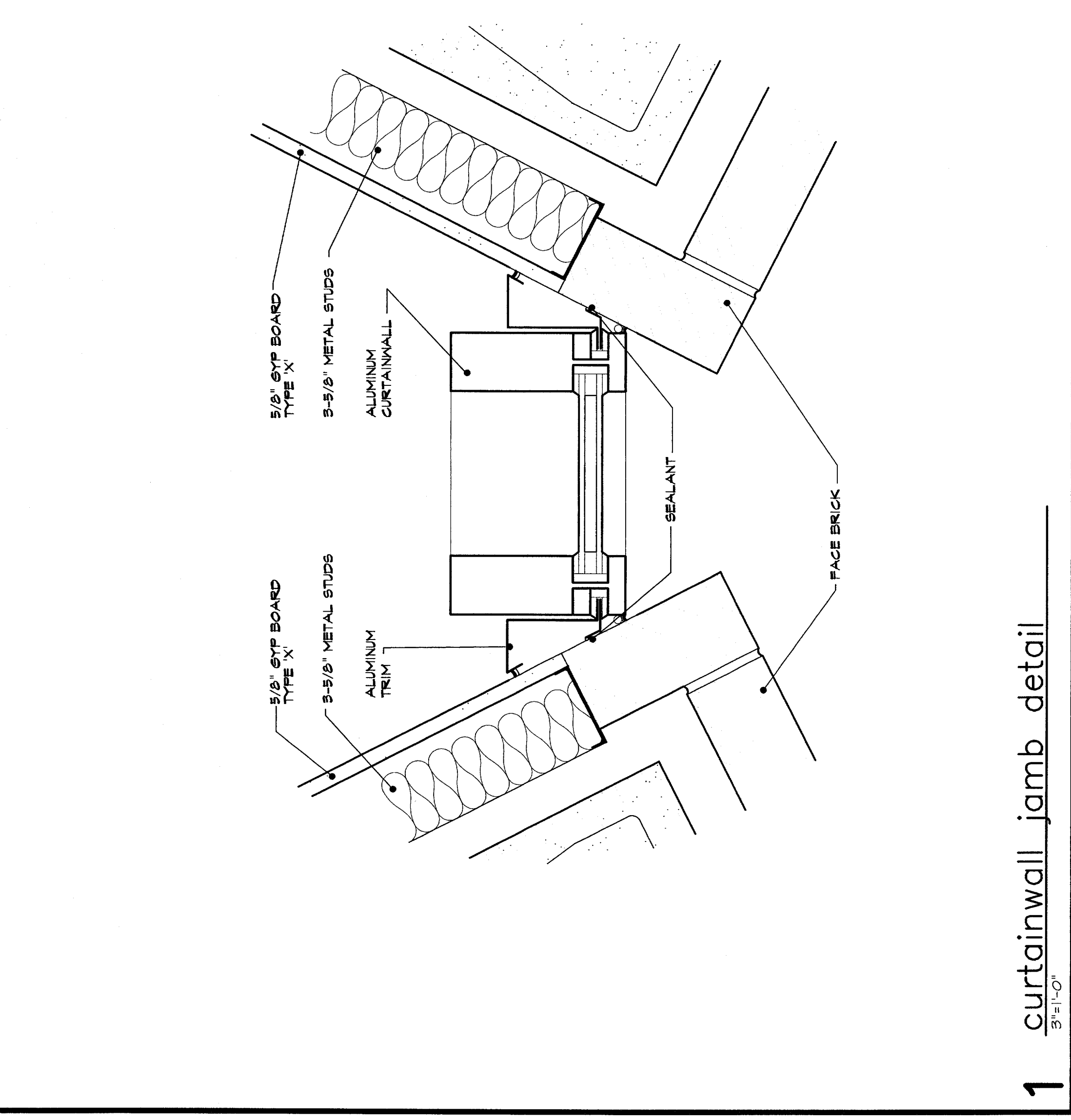

**1** curtainwall jamb detail  
3/4" x 10"

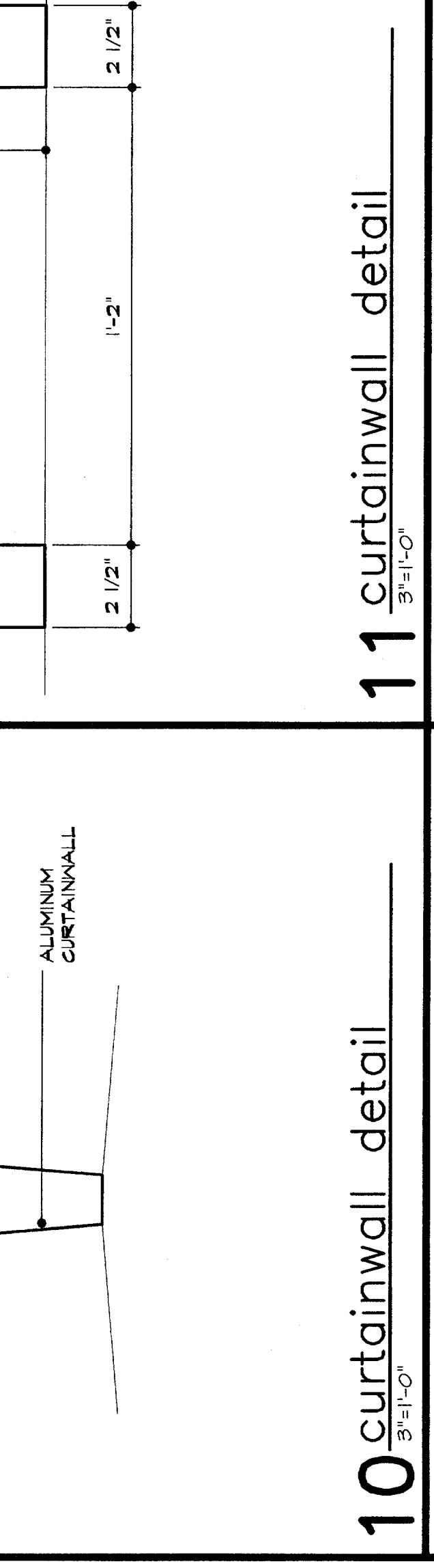

**11** curtainwall detail  
3/4" x 10"

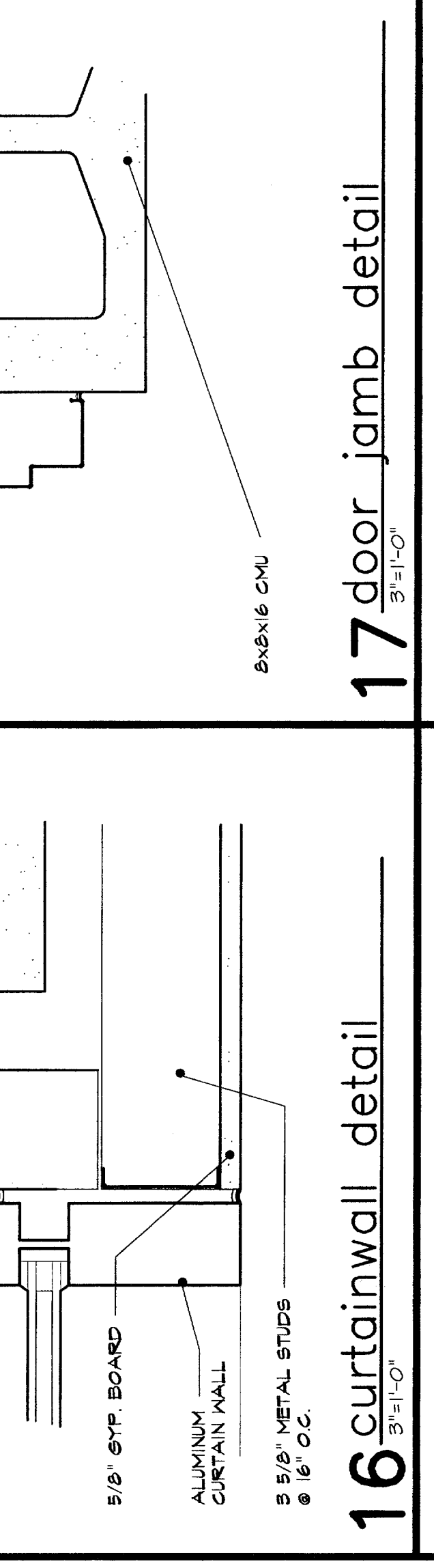

**17** door jamb detail  
3/4" x 10"

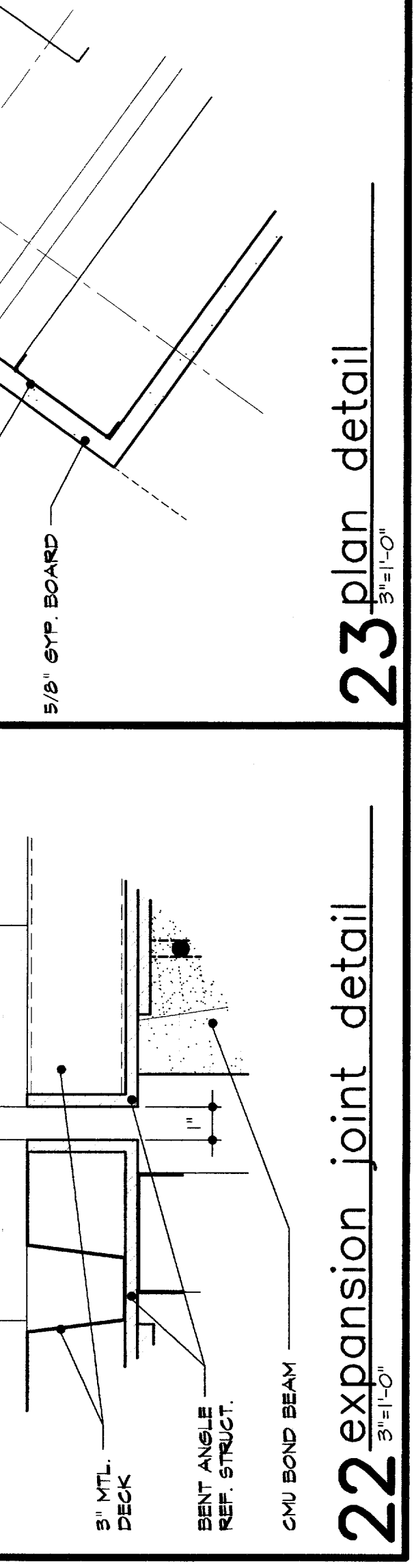

**23** plan detail  
3/4" x 10"



**10** curtainwall detail  
3/4" x 10"



**16** curtainwall detail  
3/4" x 10"



**22** expansion joint detail  
3/4" x 10"



**26** hollow metal jamb  
3/4" x 10"