

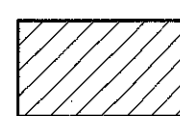
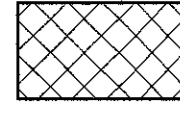
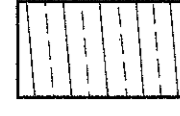
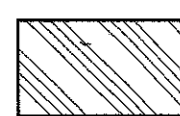
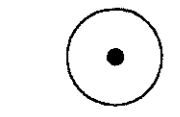
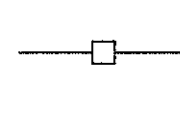
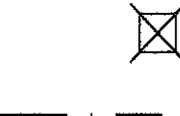

LEGEND

- R&S REMOVE AND SALVAGE
- R&D REMOVE AND DISPOSE
-  R&D ASPHALT PAVING & SUBBASE MATERIAL
-  R&D GRAVEL PAVING
-  R&D CONCRETE PAVING AND SUBBASE MATERIAL
-  R&S BRICK PAVERS; R&D SUBBASE MATERIAL
-  TREE TO BE PROTECTED
-  SILT FENCE
-  R&D CATCH BASIN
-  LIMIT OF WORK

SEE GENERAL NOTES, SHEET C1-2

ADDISON CIRCLE DRIVE

ADDISON ROAD

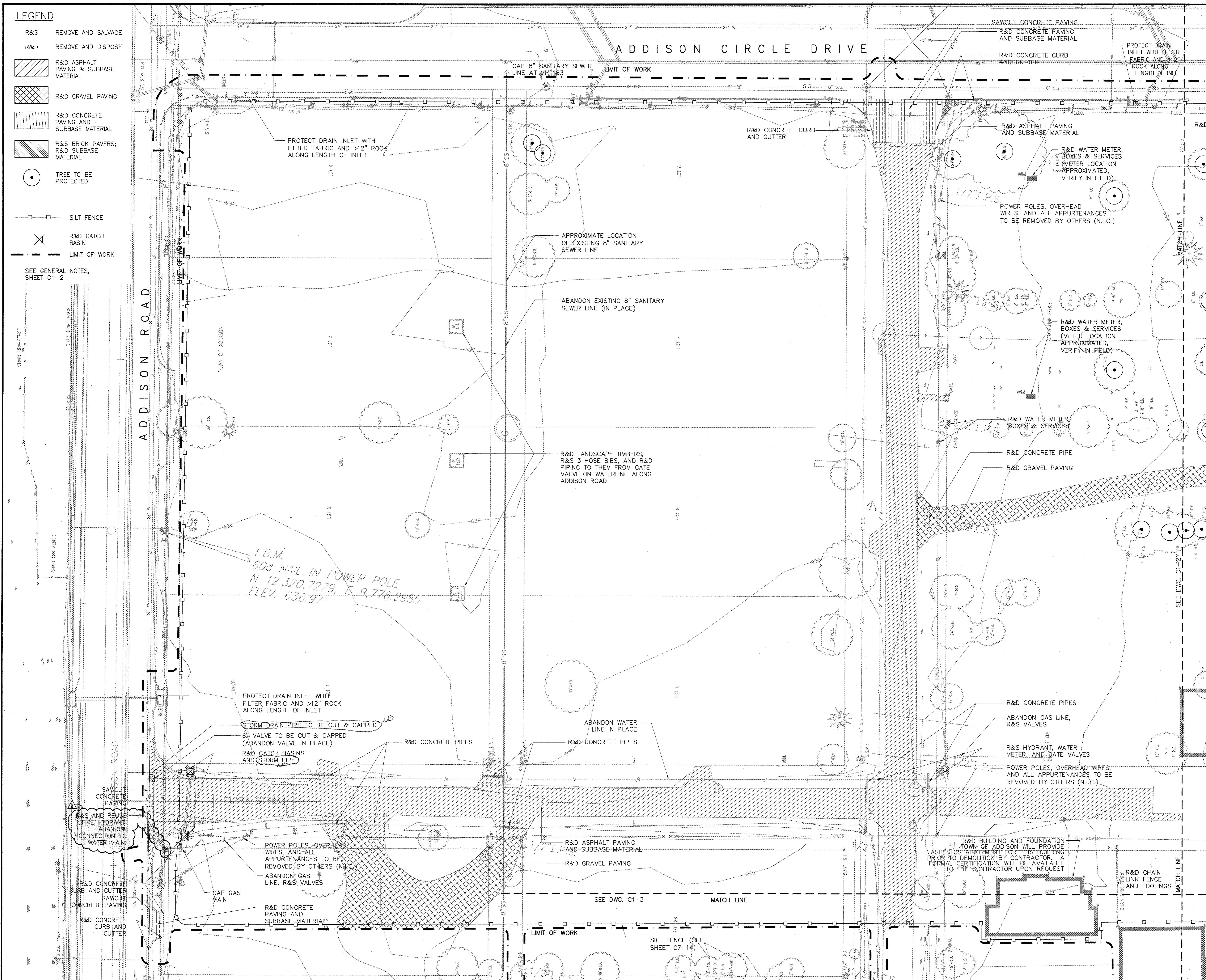

SASAKI
 Interdisciplinary Design
 64 Pleasant Street, Watertown, Massachusetts 02472 USA
 T 617 926 3300 F 617 924 2748 W www.sasaki.com

BULLETIN #	12-30-02	
ISSUED FOR CONSTRUCTION	11-26-02	
ADDENDUM #2	10-21-02	
ISSUED FOR CONSTRUCTION	09-30-02	
No.	Description	Date
DWG ISSUE & REVISION HISTORY		

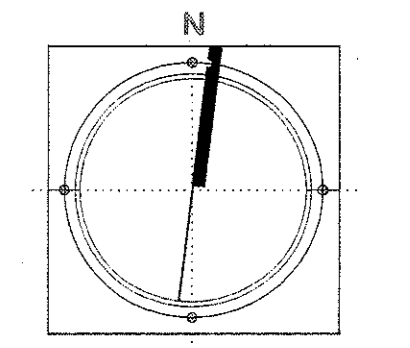

Project Title:
ADDISON ARTS & EVENTS DISTRICT
 ADDISON, TEXAS

Drawing Title:
**SITE PREPARATION/
 DEMOLITION/EROSION
 CONTROL PLAN**

Project No. 14516.00 Scale: 1"=20'-0"
 Drawn By: LS
 Checked By: DC
 Approved By: SEH
 Date: September 30, 2002

Drawing No. **C1-1**