

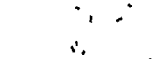







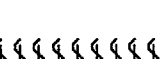

LEGEND

-  LAWN (IRRIGATED)
-  ANNUAL FLOWER DISPLAY
-  DWARF MONDO GRASS
-  ASIAN JASMINE
-  ST. JOHNSWORT
-  FOUNTAIN GRASS
-  LIRIOPE
-  PROPOSED TREES
-  PROPOSED EVERGREEN TREES
-  EXISTING TREES TO REMAIN
-  ROSE
-  VINE



NOTE: FOR PLANT LIST SEE L2-1

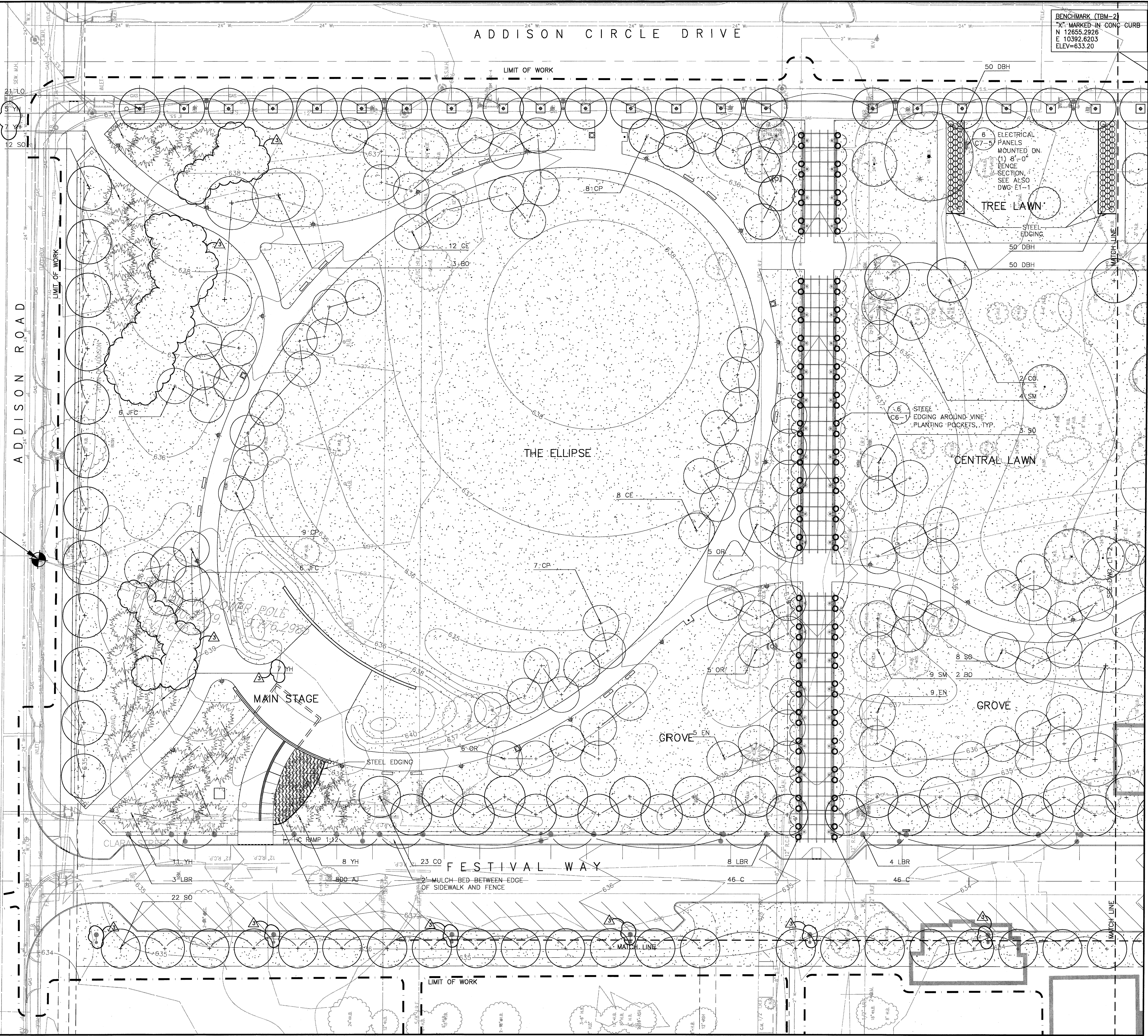

BENCHMARK (TBM-2)
 "X" MARKED IN CONC CURB
 N 12655.2926
 E 10392.6203
 ELEV=633.20

BENCHMARK (TBM-1)
 60d NAIL IN POWER POLE
 N 12320.7279
 E 9776.2985
 ELEV=636.97

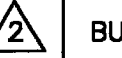
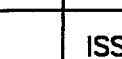
SASAKI
 Interdisciplinary Design
 64 Pleasant Street, Watertown, Massachusetts 02472 USA
 1 617 926 3300 1 617 924 2745 www.sasaki.com

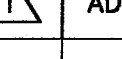
	BULLETIN #2	03-10-03
	BULLETIN #1	12-30-02
	ISSUED FOR CONSTRUCTION	11-26-02
	ADDENDUM #2	10-21-02
	ISSUED FOR CONSTRUCTION	09-30-02
No.	Description	Date

DWG ISSUE & REVISION HISTORY

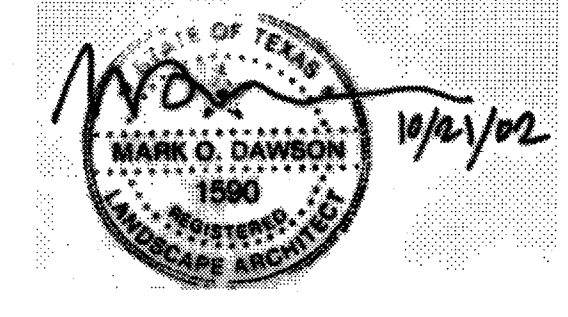
Stamp

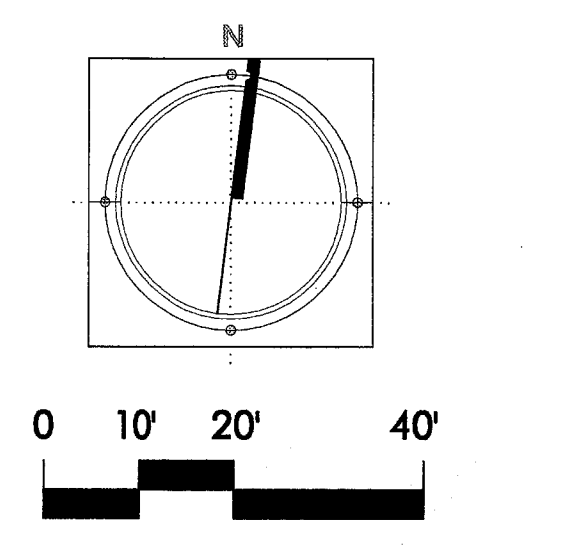

Project Title:
ADDISON ARTS & EVENTS DISTRICT
 ADDISON, TEXAS

Drawing Title:
PLANTING PLAN

Project No. 14516.00 Scale: 1"=20'-0"
 Drawn By: CB
 Checked By: DC
 Approved By: MOD
 Date: September 30, 2002

Drawing No. **L1-1**