

DISCLAIMER
 The use of this standard is governed by the "Texas Engineering Practice Act". No warranty of any kind is made by TxDOT for any purpose whatsoever. TxDOT assumes no responsibility for the conversion of this standard to other formats or for incorrect results or damages resulting from its use.

DN: 4
 CK: 5
 DW: 6
 CK: 7
 DATE: 11/15/16
 ACC: 12
 FILE: 13
 14
 15
 16
 17
 18
 19
 20
 21
 22
 23
 24
 25
 26
 27
 28
 29
 30
 31
 32
 33
 34
 35
 36
 37
 38
 39
 40
 41
 42
 43
 44
 45
 46
 47
 48
 49
 50

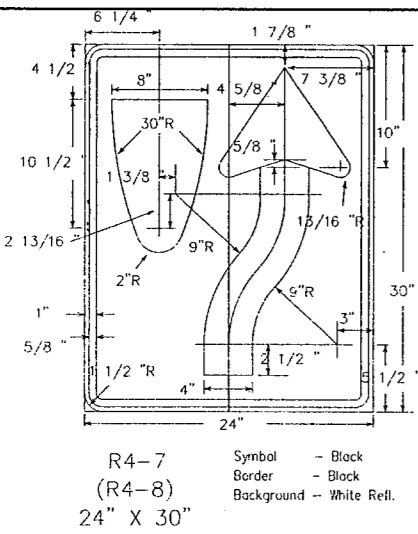

R4-7
 (R4-8)
 24" X 30"
 Symbol - Black
 Border - Black
 Background - White Refl.

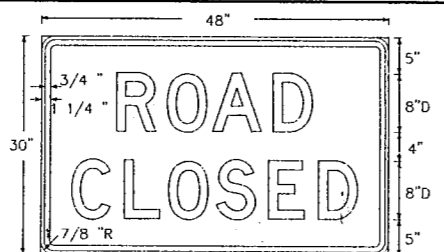

R11-2
 48" X 30"
 Letters - Black
 Border - Black
 Background - White Refl.

Alternate 1st line legend
 STREET 8"D R11-2S
 RAMPI 8"D R11-2R
 BRIDGE 8"D R11-2B

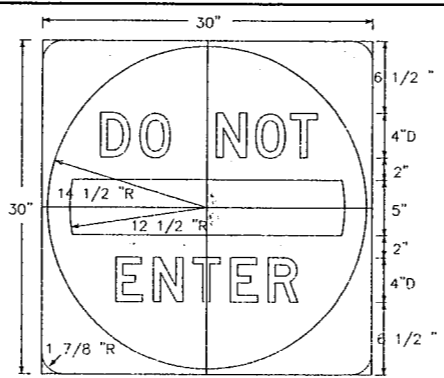

R5-1
 30" X 30"
 Letters - White Refl.
 Bar - White Refl.
 Border - White Refl.
 Background - Red Refl.

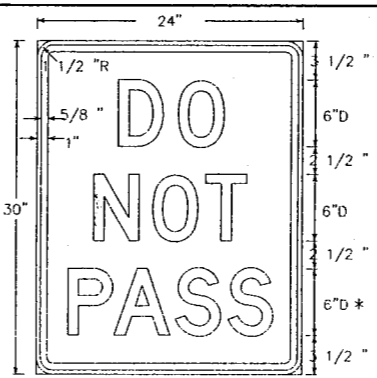

R4-1
 24" X 30"
 Letters - Black
 Border - Black
 Background - White Refl.

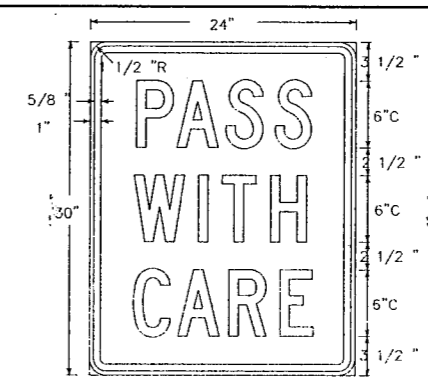

R4-2
 24" X 30"
 Letters - Black
 Border - Black
 Background - White Refl.

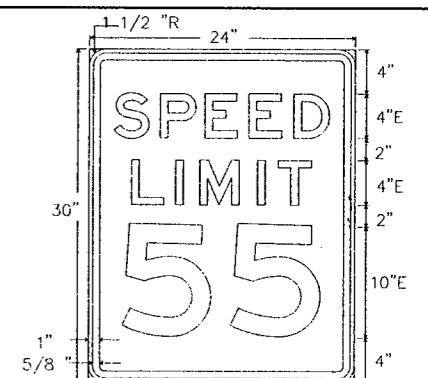

R2-1
 24" X 30"
 Letters - Black
 Border - Black
 Background - White Refl.

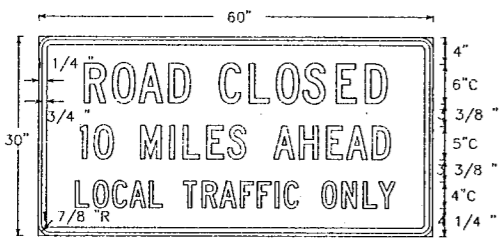

R11-3a
 60" X 30"
 Letters - Black
 Numerals - Black
 Border - Black
 Background - White Refl.

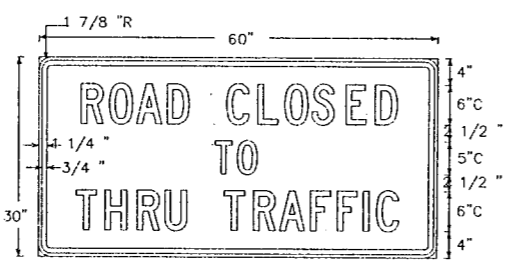

R11-4
 60" X 30"
 Letters - Black
 Border - Black
 Background - White Refl.

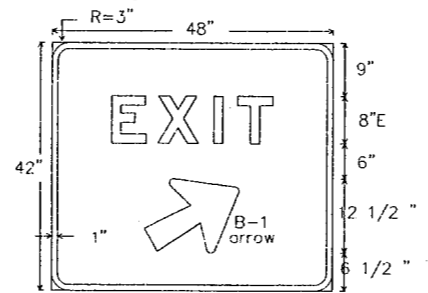

E5-1a
 48" X 42"
 Letters - White Refl.
 Numerals - White Refl.
 Symbol - White Refl.
 Background - Green Refl.

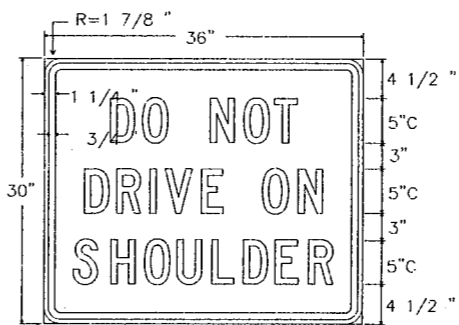

R4-3a
 36" X 30"
 Letters - Black
 Border - Black
 Background - White Refl.

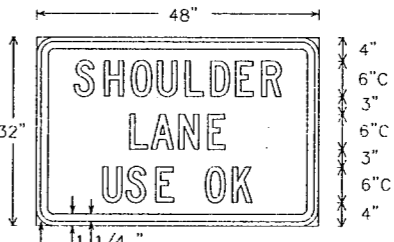

R4-3d
 48" X 32"
 Letters - Black
 Border - Black
 Background - White Refl.

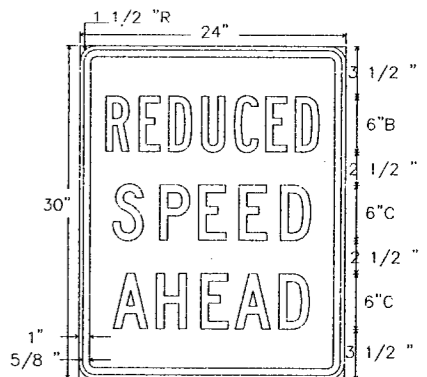

R2-5a
 24" X 30"
 Letters - Black
 Border - Black
 Background - White Refl.

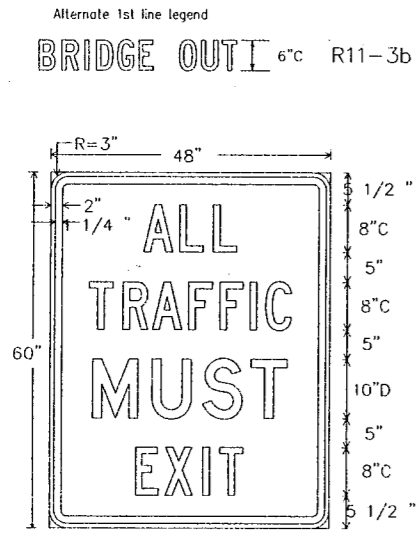

R3-22
 48" X 60"
 Letters - Black
 Border - Black
 Background - White Refl.

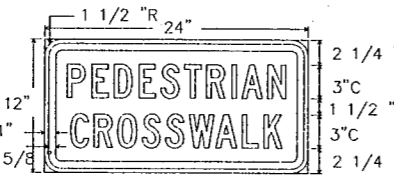

R5-7
 24" X 12"
 Letters - Black
 Border - Black
 Background - White Refl.

ER20-5
 36" X 36"
 Letters - Black
 Border - Black
 Background - White Refl.

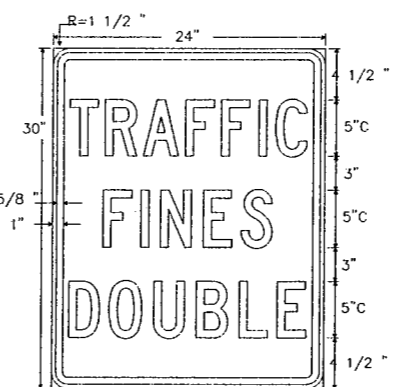
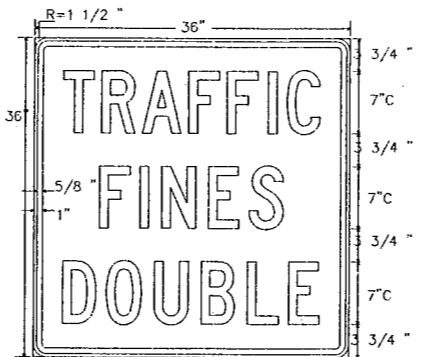

R20-5
 24" X 30"
 Letters - Black
 Border - Black
 Background - White Refl.

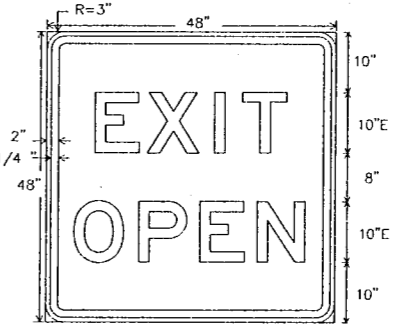

E5-2
 48" X 48"
 Letters - Black
 Border - Black
 Background - Orange Refl.

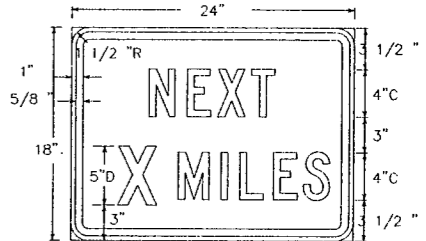

R20-1
 24" X 18"
 Letters - Black
 Border - Black
 Background - White Refl.

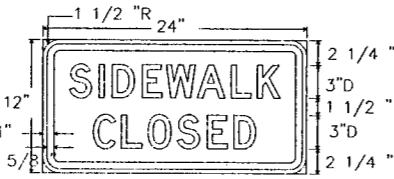

R5-8
 24" X 12"
 Letters - Black
 Border - Black
 Background - White Refl.

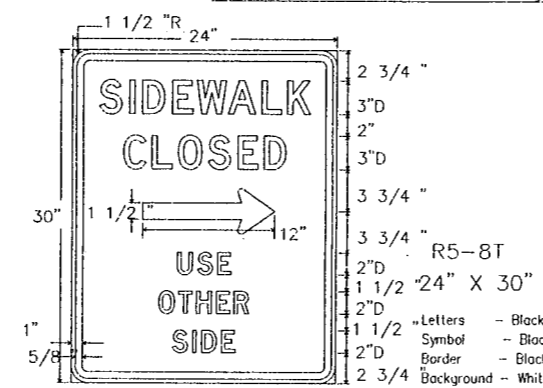

R5-8T
 24" X 30"
 Letters - Black
 Symbol - Black
 Border - Black
 Background - White Refl.

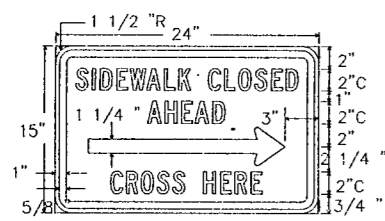

R5-9a
 24" X 15"
 Letters - Black
 Symbol - Black
 Border - Black
 Background - White Refl.

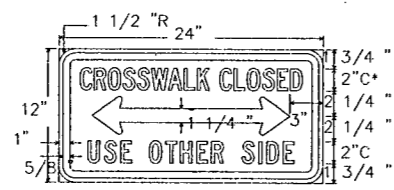

R5-9
 24" X 12"
 Letters - Black
 Symbol - Black
 Border - Black
 Background - White Refl.

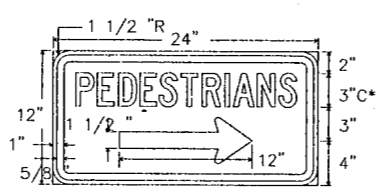

R5-7T
 24" X 12"
 Letters - Black
 Symbol - Black
 Border - Black
 Background - White Refl.

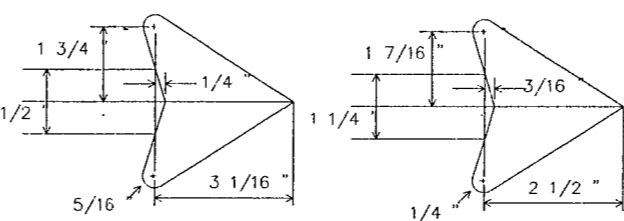

Signs E5-1a, E5-2 and R5-1 - letters, border and symbol may be fabricated from FLAT REFLECTIVE SHEETING, TYPE C.

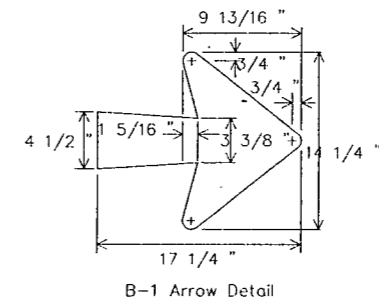

STANDARD PLANS
 TEXAS DEPARTMENT OF TRANSPORTATION
 Traffic Operations Division

BARRICADE AND CONSTRUCTION STANDARDS
 REGULATORY AND GUIDE SIGNS BC(9)-98

© TxDOT February 1998	DM - GB	DC - DTN	DR - DN	OK - GB	REV NO.
STATE DISTRICT	FEDERAL REGION	FEDERAL AID PROJECT		SHEET	
DALLAS	6	CM 97 (449)		70	
COUNTY	CONTROL	SECTION	JOB	HIGHWAY	
DALLAS	8050	18	034	BELT LINE	