

MEDIAN DIMENSION CHART

B	C	D	E	F	G	H	I	J	K	L	M	N
12	4.00'S	3.80'S	3.20'S	2.19'S	0.78'S	1.00'N	2.78'N	4.19'N	5.20'N	5.80'N	22.56'	1.00'
13	3.50'S	3.30'S	2.70'S	1.69'S	0.28'S	1.50'N	3.28'N	4.69'N	5.70'N	6.30'N	23.56'	1.00'
14	3.00'S	2.80'S	2.20'S	1.19'S	0.22'N	2.00'N	3.78'N	5.19'N	6.20'N	6.80'N	22.68'	2.50'
15	2.50'S	2.30'S	1.70'S	0.69'S	0.72'N	2.50'N	4.28'N	5.69'N	6.70'N	7.30'N	23.71'	2.50'
16	2.00'S	1.80'S	1.20'S	0.19'S	1.22'N	3.00'N	4.78'N	6.19'N	7.20'N	7.80'N	23.46'	3.50'
17	1.50'S	1.30'S	0.70'S	0.31'N	1.72'N	3.50'N	5.28'N	6.69'N	7.70'N	8.30'N	24.48'	3.50'
18	1.00'S	0.80'S	0.20'S	0.81'N	2.22'N	4.00'N	5.78'N	7.19'N	8.20'N	8.80'N	25.44'	3.50'
19	0.50'S	0.30'S	0.30'N	1.31'N	2.72'N	4.50'N	6.28'N	7.69'N	8.70'N	9.30'N	26.34'	3.50'
20	0.00'	0.20'N	0.80'N	1.81'N	3.22'N	5.00'N	6.78'N	8.19'N	9.20'N	9.80'N	26.72'	4.00'
21	0.50'N	0.70'N	1.30'N	2.31'N	3.72'N	5.50'N	7.28'N	8.69'N	9.70'N	10.30'N	27.57'	4.00'
22	1.00'N	1.20'N	1.80'N	2.81'N	4.22'N	6.00'N	7.78'N	9.19'N	10.20'N	10.80'N	28.39'	4.00'
23	1.50'N	1.70'N	2.30'N	3.31'N	4.72'N	6.50'N	8.28'N	9.69'N	10.70'N	11.30'N	29.17'	4.00'
24	2.00'N	2.30'N	2.80'N	3.81'N	5.22'N	7.00'N	8.78'N	10.19'N	11.20'N	11.80'N	29.92'	4.00'

N = NORTH OF CENTERLINE
S = SOUTH OF CENTERLINE

CURVE DATA C3 B C4 FOR 7' A = 14'

A	Δ	R	T	L	M	N
7	18°22'52"	50'	8.09'	16.04'	16.45'	1.00'
8	20°09'11"		8.89'	17.59'	17.88'	1.00'
9	21°47'12"		9.62'	19.01'	19.19'	1.00'
10	23°18'41"		10.31'	20.34'	20.39'	1.00'
11	24°44'50"		10.97'	21.60'	21.51'	1.00'
12	26°06'32"		11.59'	22.78'	22.56'	1.00'
13	27°24'27"		12.19'	23.92'	23.56'	1.00'
14	28°08'28"		12.76'	25.00'	24.68'	2.50'

CURVE DATA C2 FOR Δ = 11°28'40"

R = 250'
T = 25.13'
L = 50.08'

CURVE DATA C3 & C4 FOR 12' B = 24'

B	Δ	R	T	L
12	26°06'32"	50.00'	11.59'	22.78'
13	27°24'27"		12.19'	23.92'
14	28°08'28"		12.76'	25.00'
15	28°31'32"		13.31'	26.08'
16	28°45'51"		13.84'	27.16'
17	28°48'51"		14.35'	28.24'
18	28°48'58"		14.84'	29.32'
19	28°45'43"		15.31'	30.40'
20	28°35'30"		15.76'	31.48'
21	30°49'46"		16.19'	32.56'
22	32°01'26"		16.59'	33.64'
23	33°10'48"		16.96'	34.72'
24	34°18'05"		17.31'	35.80'

CURVE DATA C5 FOR 12' B = 24'

B	Δ	R	T	L
12	127°47'32"	1.00'	2.04'	2.23'
13	125°12'46"	1.00'	1.93'	2.19'
14	129°43'08"	2.50'	5.33'	5.66'
15	126°57'31"	2.50'	5.01'	5.54'
16	129°09'33"	3.50'	7.36'	7.89'
17	126°21'44"	3.50'	6.92'	7.72'
18	123°41'38"	3.50'	6.54'	7.56'
19	120°52'03"	3.50'	6.17'	7.38'
20	120°48'56"	4.00'	7.04'	8.43'
21	118°21'08"	4.00'	6.70'	8.26'
22	115°57'07"	4.00'	6.40'	8.10'
23	113°38'22"	4.00'	6.12'	7.93'
24	111°23'48"	4.00'	5.86'	7.78'

CURVE DATA C5 FOR 7' A = 14'

A	Δ	R	T	L
7	143°14'15"	1.00'	3.01'	2.50'
8	139°41'38"	1.00'	2.72'	2.44'
9	136°25'35"	1.00'	2.50'	2.38'
10	133°22'36"	1.00'	2.32'	2.33'
11	130°30'20"	1.00'	2.17'	2.28'
12	127°47'32"	1.00'	2.04'	2.23'
13	125°12'46"	1.00'	1.93'	2.19'
14	123°08'08"	2.50'	5.33'	5.66'

LEFT TURN LANE (AS APPLICABLE)

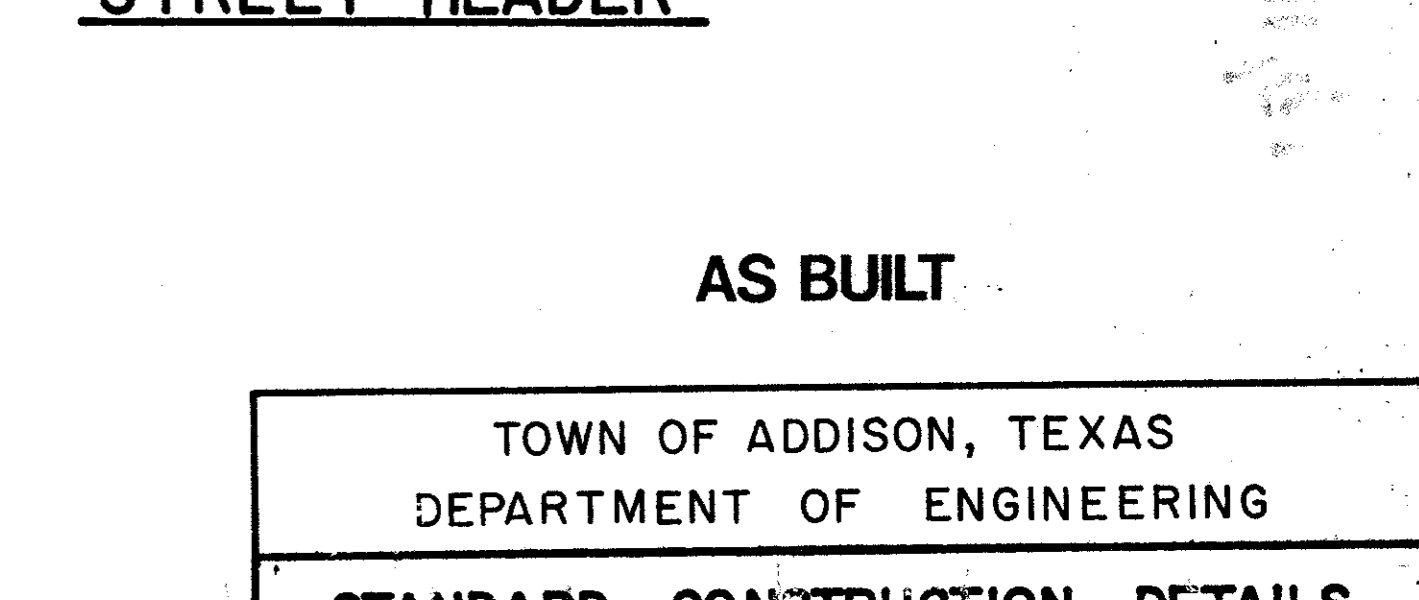
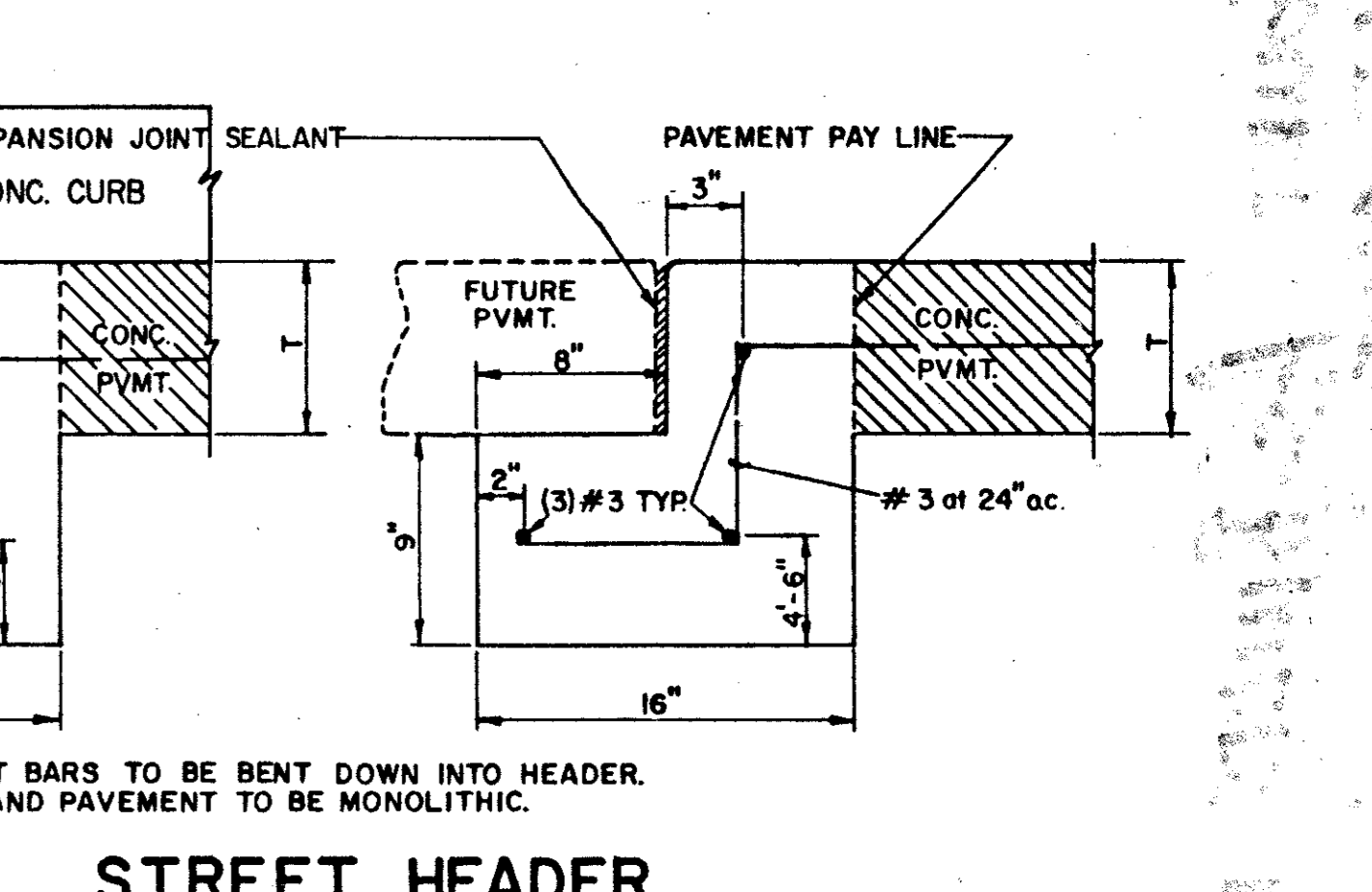
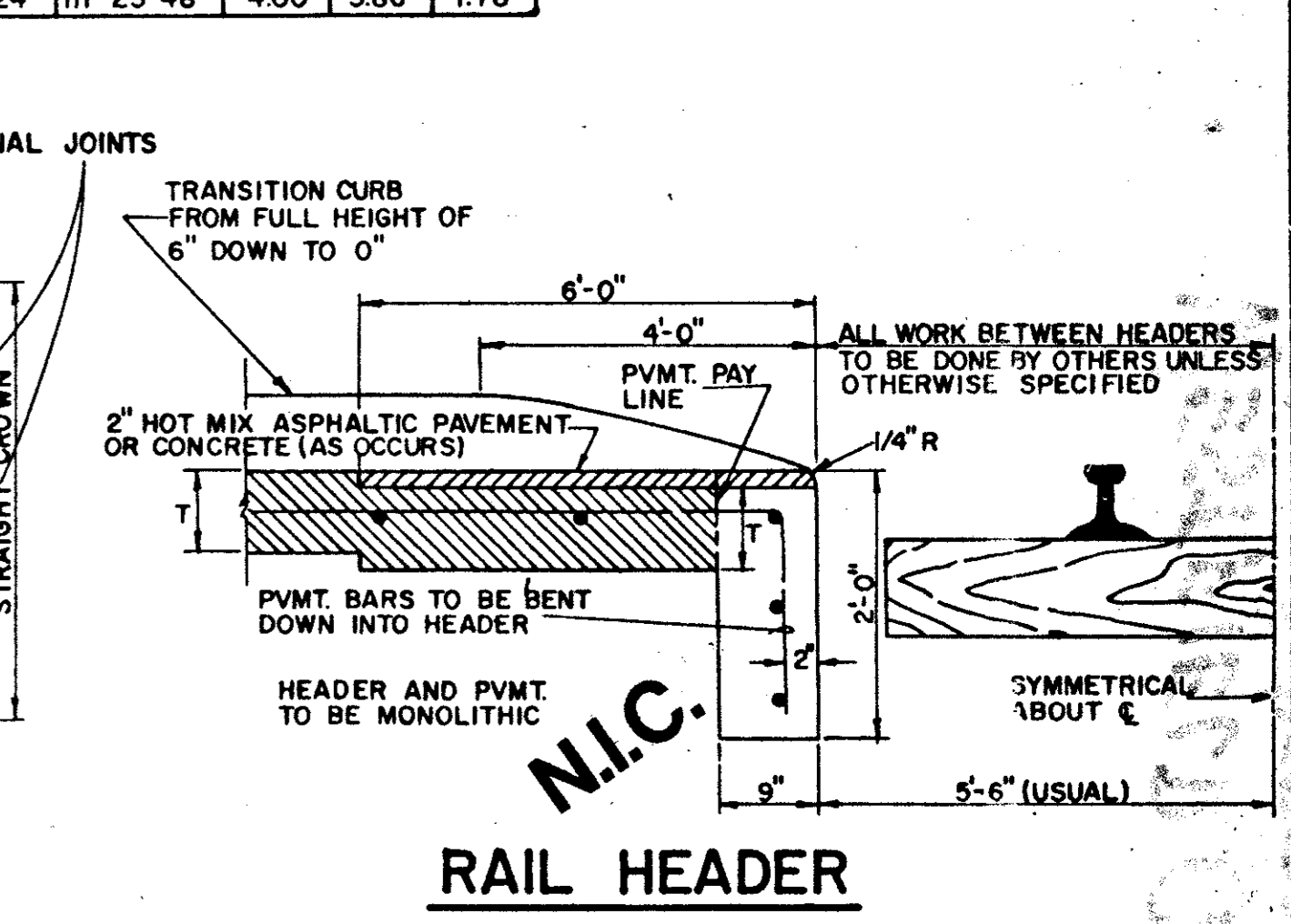
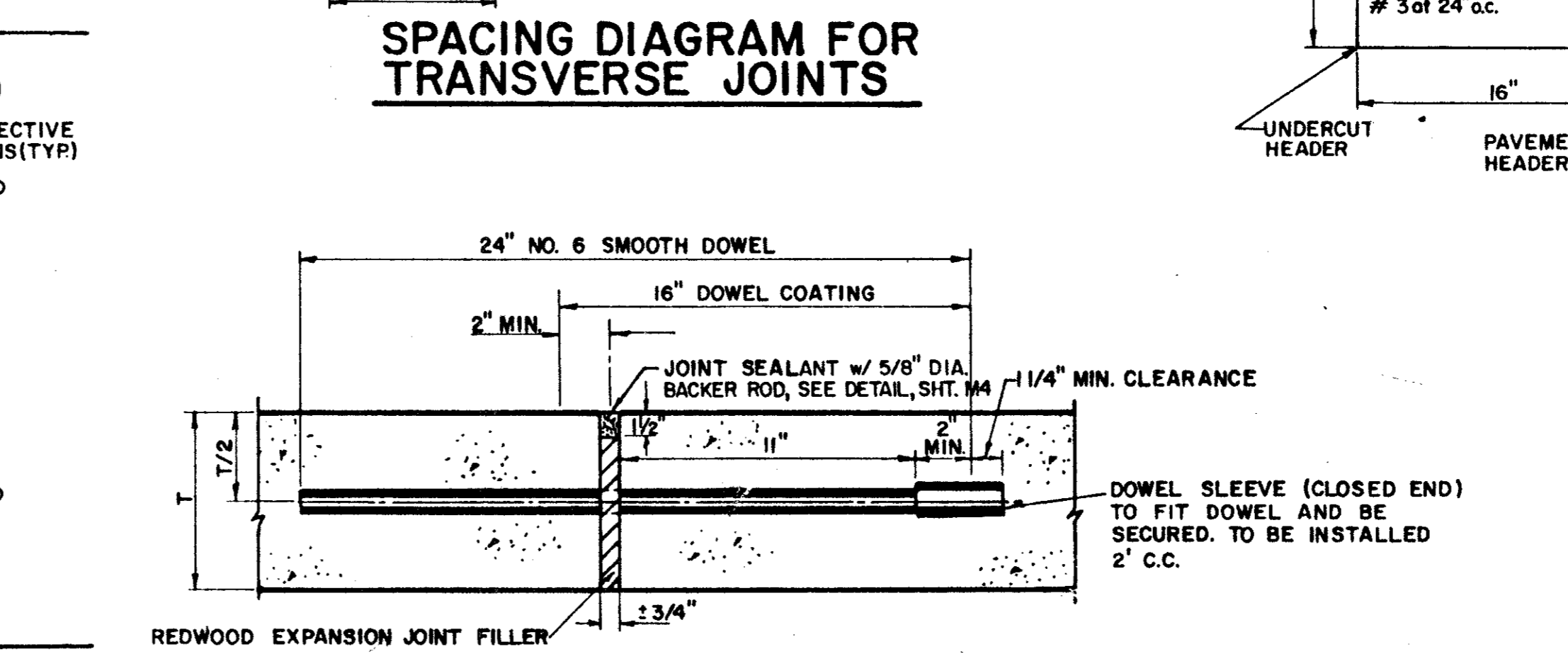
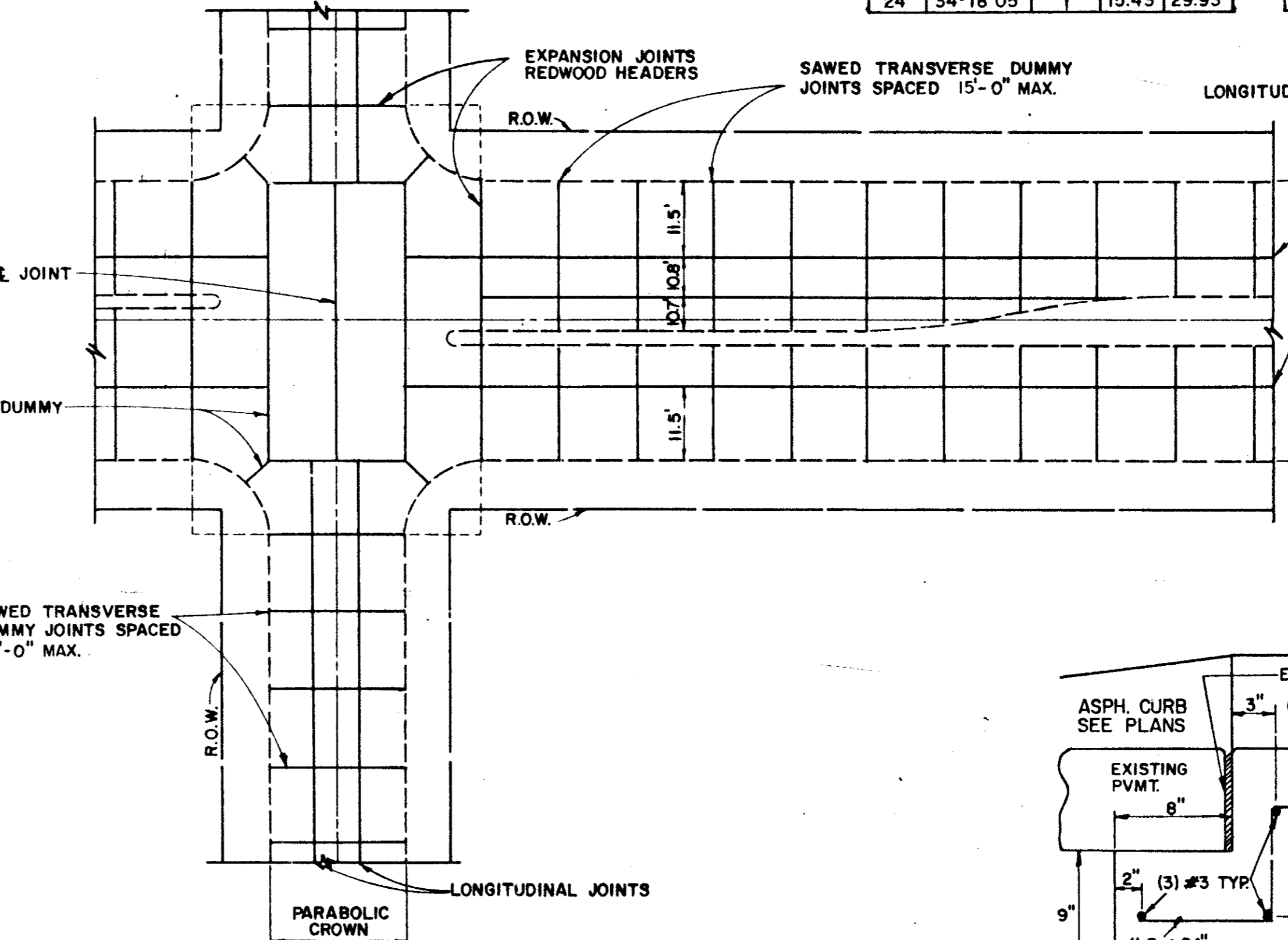
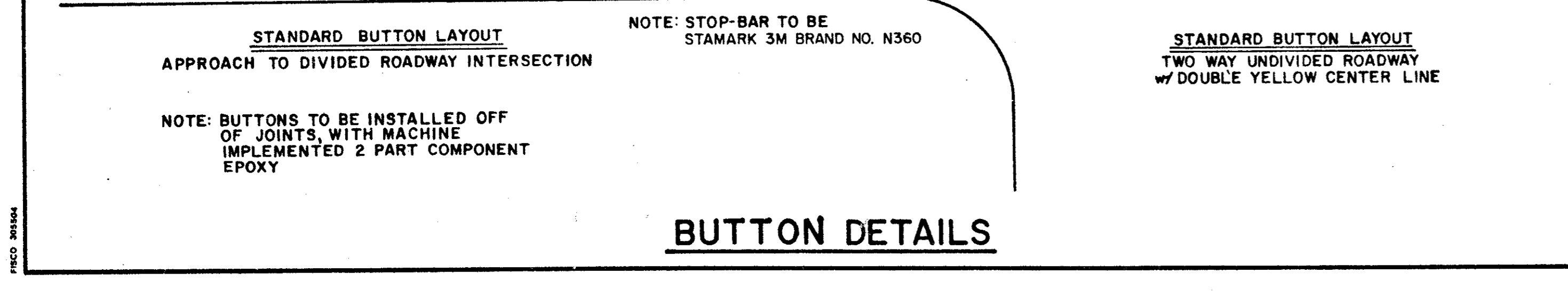
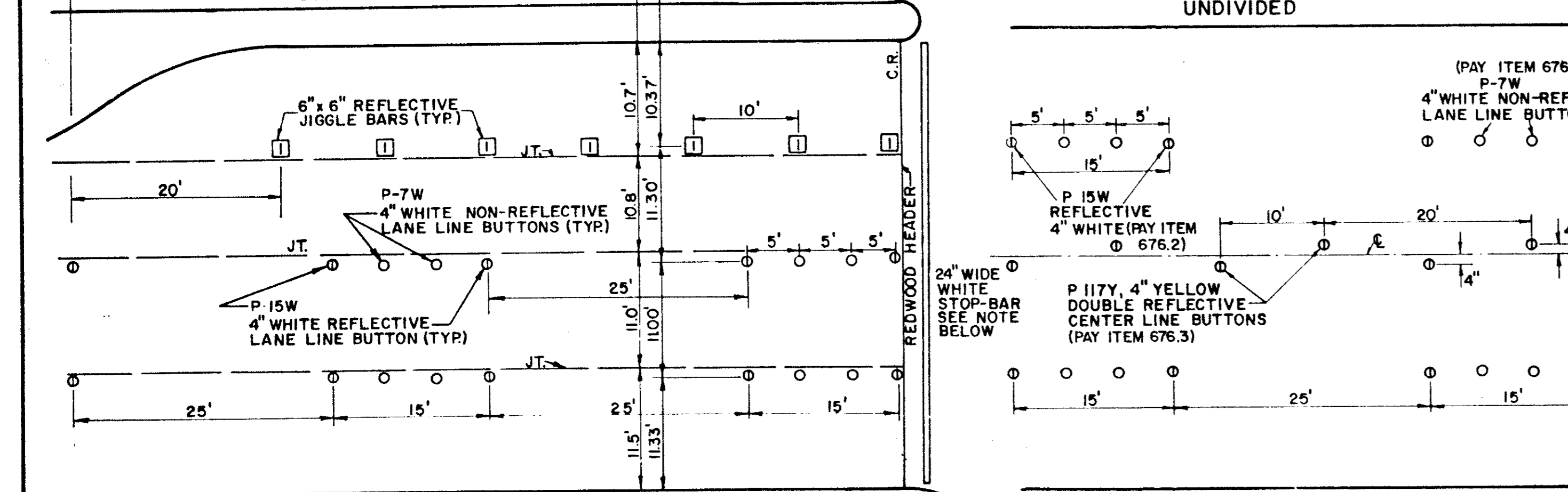
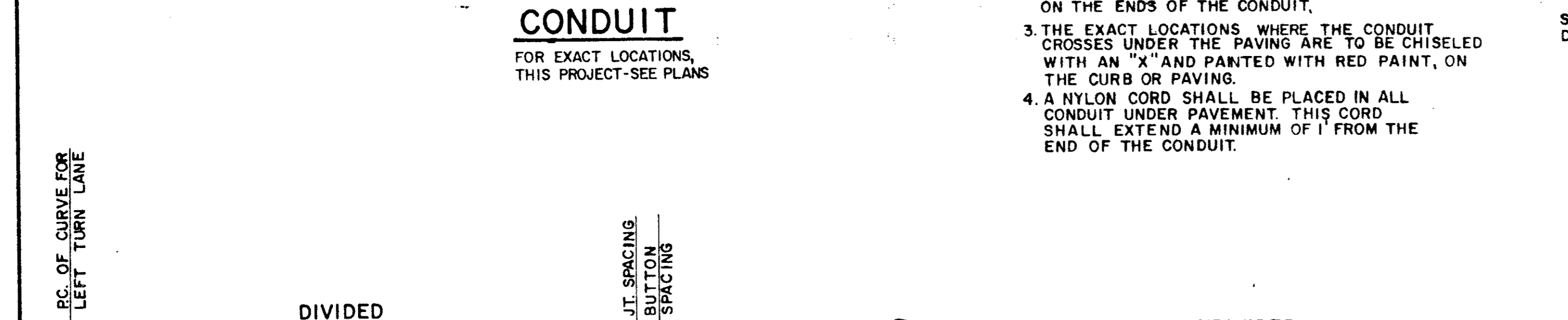
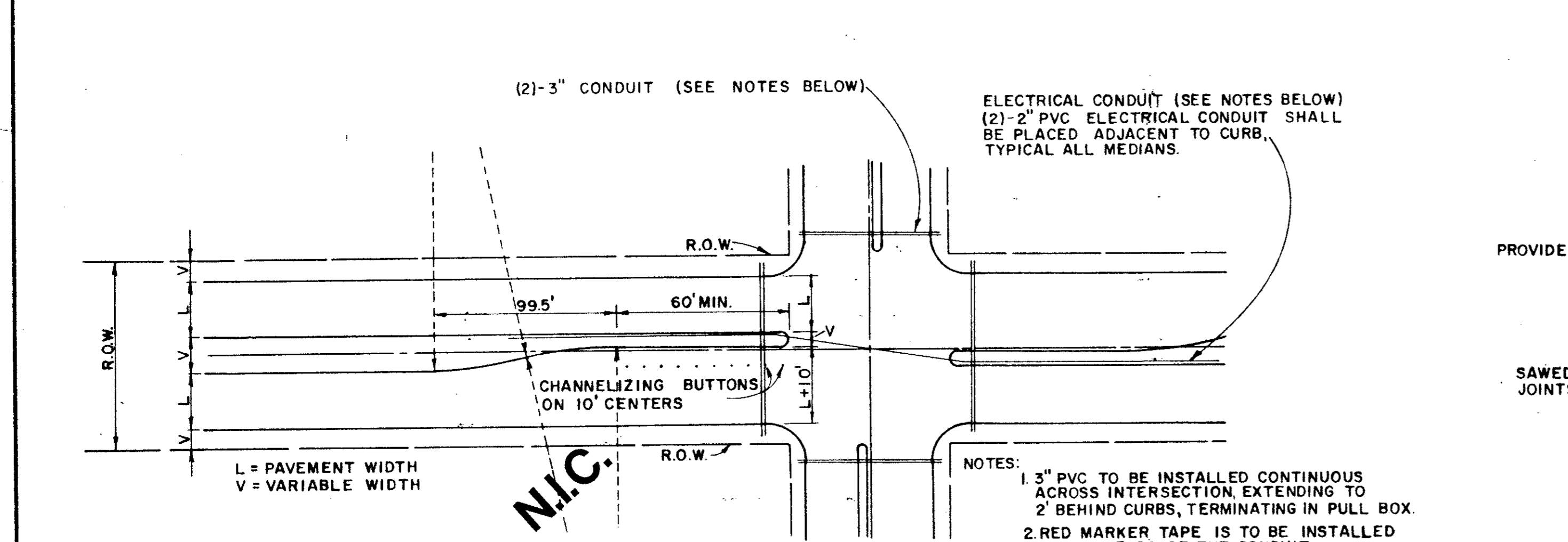

TOWN OF ADDISON, TEXAS
DEPARTMENT OF ENGINEERING

STANDARD CONSTRUCTION DETAILS PAVING

TURN LANES & JOINTS

Designed - _____ Drawn - _____ Date - JULY, 1991 Job No. - 90025-3
Approved - _____ Checked - _____ Scale - _____ Sheet D-10 of _____

