

PRELIMINARY - FOR REVIEW ONLY  
 These documents are for Design Review and not intended for Construction, Bidding or Permit Purposes. They were prepared by, or under supervision of, RICHARD K. LAIRD 59187 6/13/96  
 Type or Print Name PE \* Date

No.	REVISION	BY	DATE
TEXAS TURNPIKE AUTHORITY ADDISON AIRPORT TUNNEL			
SIGNING AND PAVEMENT MARKING LAYOUT STA. 0+00 TO STA. 10+00			
GINN THE GINN CORPORATION			SECTION XIII
DRAWN: _____	DATE: _____	DESIGNED: _____	DATE: _____
CHECKED: _____	DATE: _____	SCALE: 1" = 50'	
CONTRACT No. DNT-260 SHEET 1 OF 6			

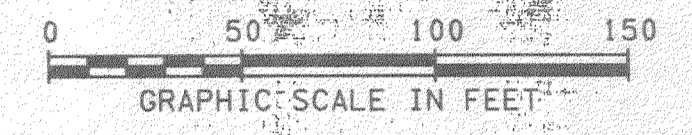

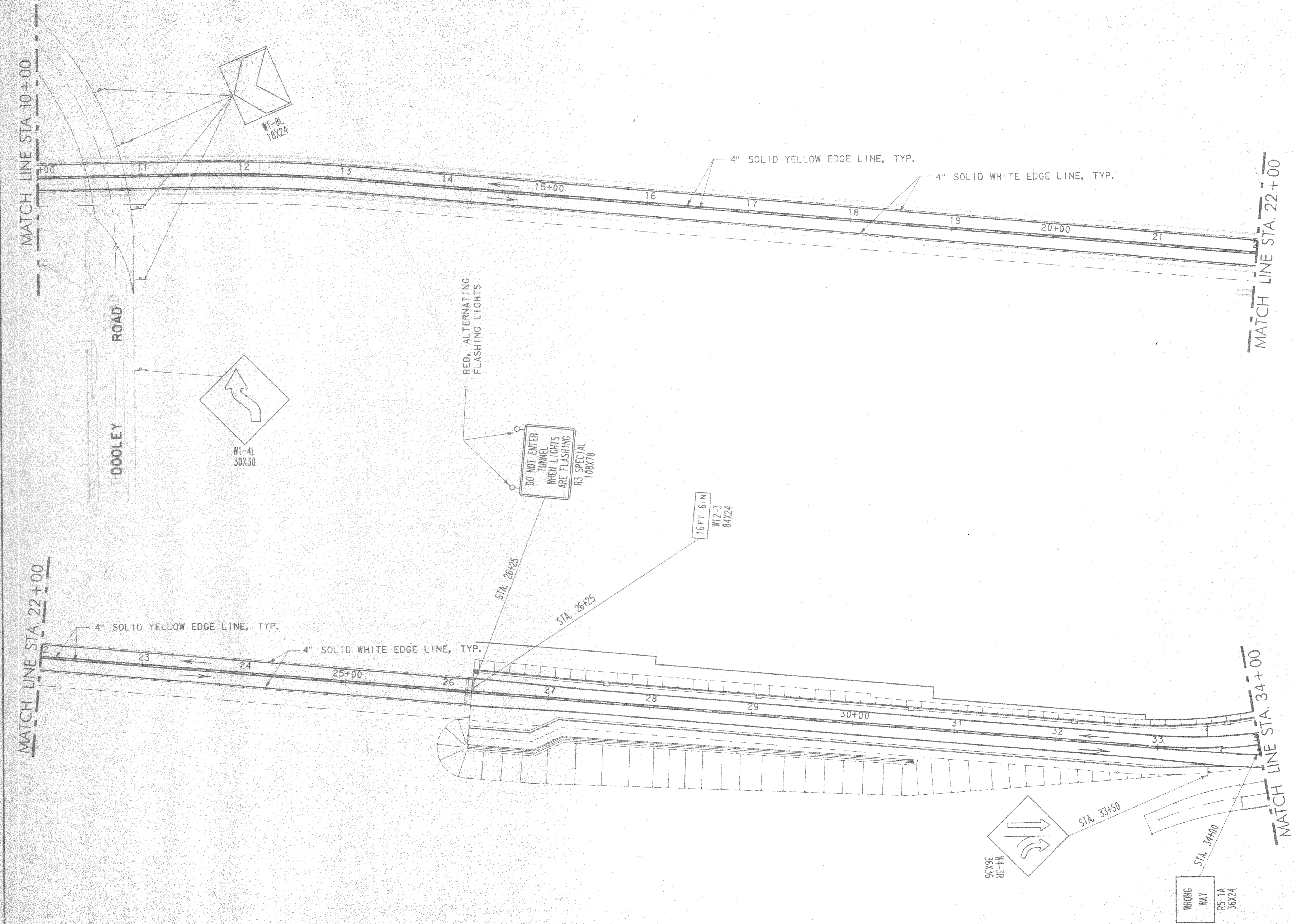

PRELIMINARY - FOR REVIEW ONLY  
 These documents are for Design Review and not intended for Construction, Bidding or Permit Purposes. They were prepared by, or under supervision of: RICHARD K. LAIRD 59187 6/13/96  
 Type or Print Name PE # Date

No.	REVISION	BY	DATE
TEXAS TURNPIKE AUTHORITY ADDISON AIRPORT TUNNEL			
SIGNING AND PAVEMENT MARKING LAYOUT STA. 10+00 TO STA. 34+00			
GINN THE GINN CORPORATION			SECTION XIII
DRAWN:	DATE:	DESIGNED:	DATE:
CHECKED:	DATE:	SCALE:	1" = 50'
CONTRACT No. DNT-260 SHEET 2 OF 6			



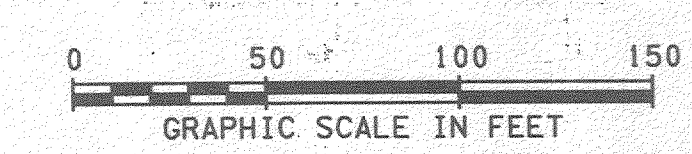
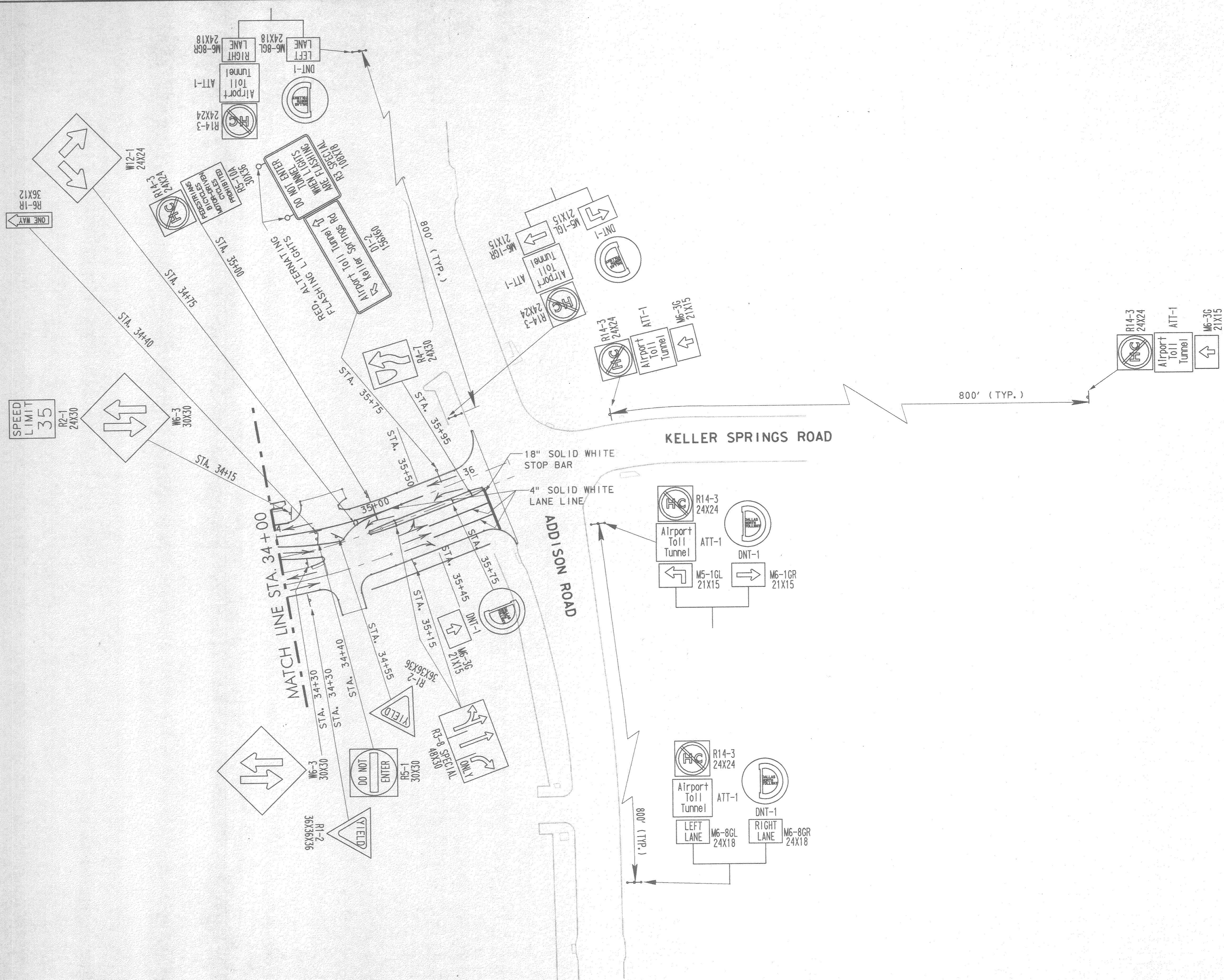

PRELIMINARY - FOR REVIEW ONLY  
 These documents are for Design Review and not intended for Construction, Bidding or Permit Purposes. They were prepared by, or under supervision of:  
 RICHARD K. LAIRD 59187 6/13/96  
 Type or Print Name PE Date

No.	REVISION	BY	DATE
TEXAS TURNPIKE AUTHORITY ADDISON AIRPORT TUNNEL			
SIGNING AND PAVEMENT MARKING LAYOUT STA. 34+00 TO ADDISON ROAD			
GINN THE GINN CORPORATION			SECTION XIII
DRAWN:	DATE:	DESIGNED:	DATE:
CHECKED:	DATE:	SCALE:	1" = 50'
CONTRACT No. DNT-260 SHEET 3 OF 6			



GENERAL NOTES:

1. THIS OVERHEAD SIGN STRUCTURE WILL BE CONSTRUCTED WITH STEEL TOWER AND STEEL TRUSS.
2. TRUSS CONSTRUCTION SHALL CONFORM TO STANDARD SHEETS HCOSS-21, COSSD AND COSSF.
3. SIGN WALKWAY WILL BE INSTALLED ON THIS CONTRACT. SIGN, SIGN WALKWAY AND SIGN LIGHT BRACKETS, AND SIGN LIGHTS WILL ALSO BE INSTALLED UNDER THIS CONTRACT.
4. SEE STANDARD SHEETS SL (MV), SWW (1), SB (SWL-1) AND SMD (P-1) FOR ADDITIONAL INFORMATION.

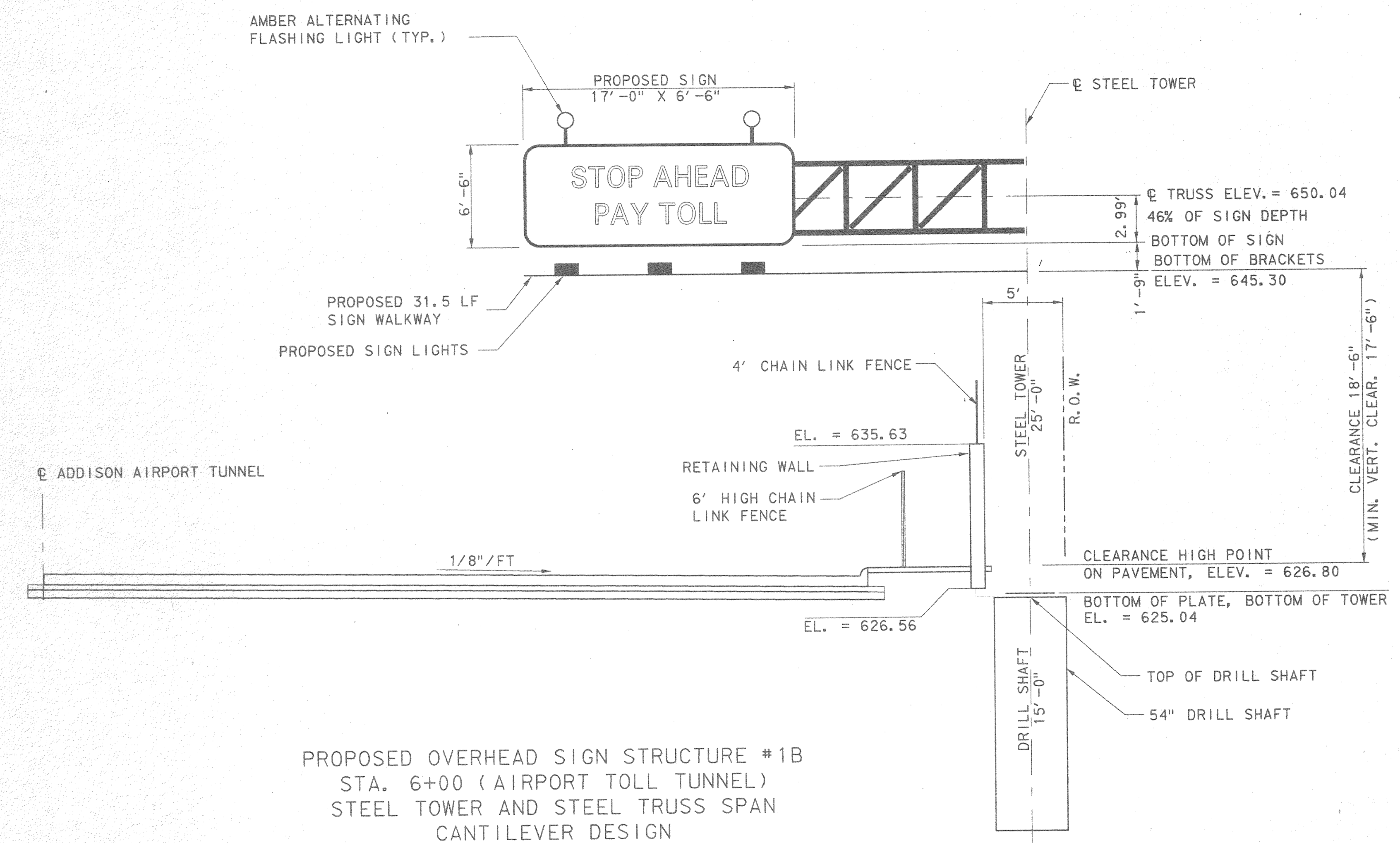

PROPOSED OVERHEAD SIGN STRUCTURE #1B  
 STA. 6+00 (AIRPORT TOLL TUNNEL)  
 STEEL TOWER AND STEEL TRUSS SPAN  
 CANTILEVER DESIGN

PRELIMINARY - FOR REVIEW ONLY  
 These documents are for Design Review and not intended for Construction, Bidding or Permit Purposes. They were prepared by, or under supervision of:  
 RICHARD K. LAIRD 59187 6/13/86  
 Type or Print Name PE # Date



No.	REVISION	BY	DATE
TEXAS TURNPIKE AUTHORITY ADDISON AIRPORT TUNNEL			
AIRPORT TOLL TUNNEL OVERHEAD SIGN STRUCTURE #1B STA. 6+00			
GINN THE GINN CORPORATION			SECTION XIII
DRAWN: TMF	DATE:	DESIGNED: SA	DATE:
CHECKED:	DATE:	SCALE: 1"=5'-0"	
CONTRACT No. DNT-260 SHEET 4 OF 6			

GENERAL NOTES:

1. THIS OVERHEAD SIGN STRUCTURE WILL BE CONSTRUCTED WITH STEEL TOWER AND STEEL TRUSS.
2. TRUSS CONSTRUCTION SHALL CONFORM TO STANDARD SHEETS HCOSS-Z1, COSSD AND COSSF.
3. SIGN WALKWAY WILL BE INSTALLED ON THIS CONTRACT. SIGN, SIGN WALKWAY AND SIGN LIGHT BRACKETS, AND SIGN LIGHTS WILL ALSO BE INSTALLED UNDER THIS CONTRACT.
4. SEE STANDARD SHEETS SL (MV), SWW (1), SB (SWL-1) AND SMD (P-1) FOR ADDITIONAL INFORMATION.

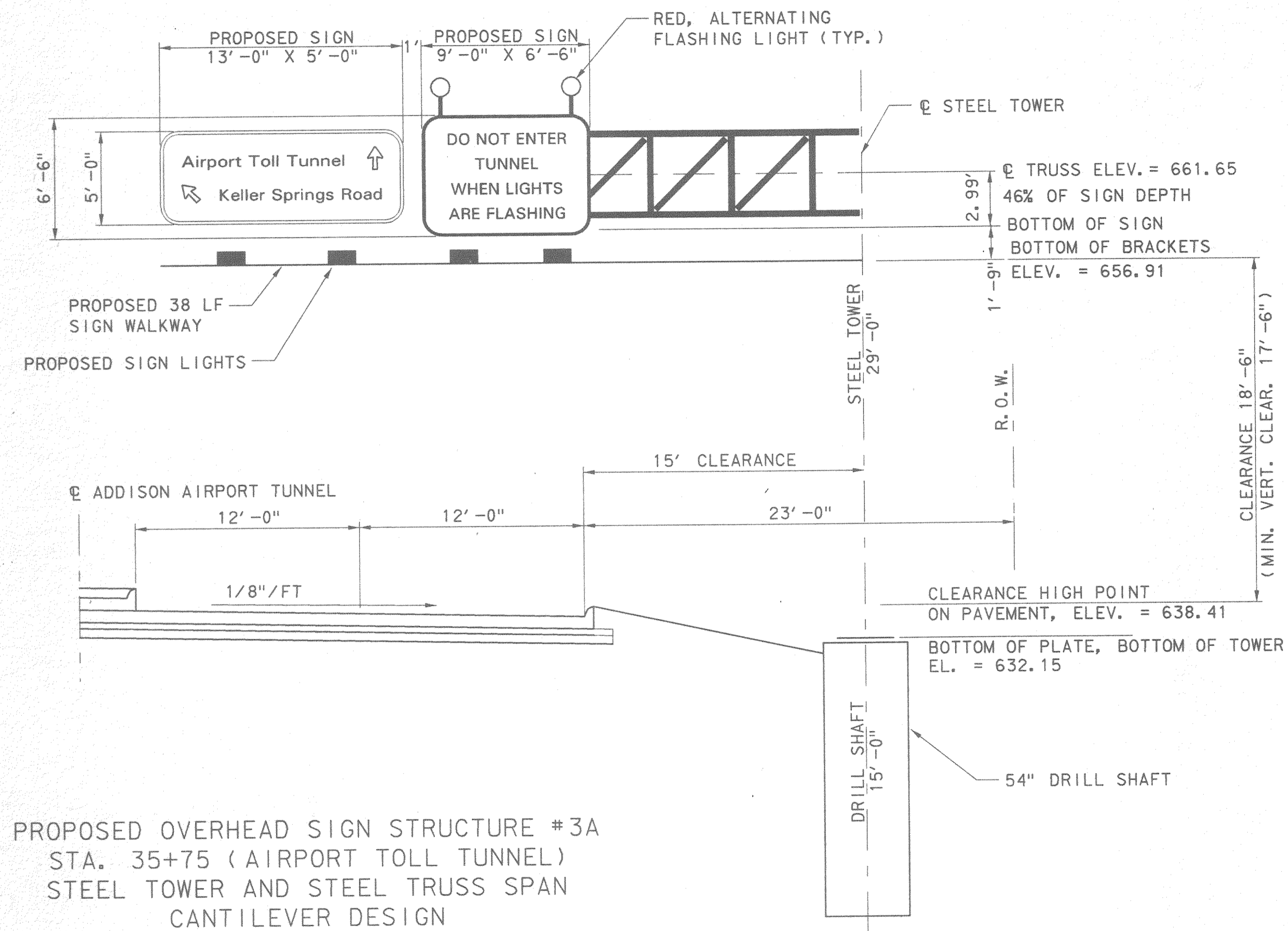

PROPOSED OVERHEAD SIGN STRUCTURE #3A  
 STA. 35+75 (AIRPORT TOLL TUNNEL)  
 STEEL TOWER AND STEEL TRUSS SPAN  
 CANTILEVER DESIGN

PRELIMINARY - FOR REVIEW ONLY  
 These documents are for Design Review and not intended for Construction, Bidding or Permit Purposes. They were prepared by, or under supervision of:  
 RICHARD K. LAIRD 59187 6/18/96  
 Type or Print Name PE # Date

No.	REVISION	BY	DATE
TEXAS TURNPIKE AUTHORITY ADDISON AIRPORT TUNNEL			
AIRPORT TOLL TUNNEL OVERHEAD SIGN STRUCTURE #3A STA. 35+75			
<b>GINN</b> THE GINN CORPORATION			SECTION XIII
DRAWN: TMF	DATE:	DESIGNED: SA	DATE:
CHECKED:	DATE:	SCALE:	1"=5'-0"
CONTRACT No. DNT-260 SHEET 5 OF 6			



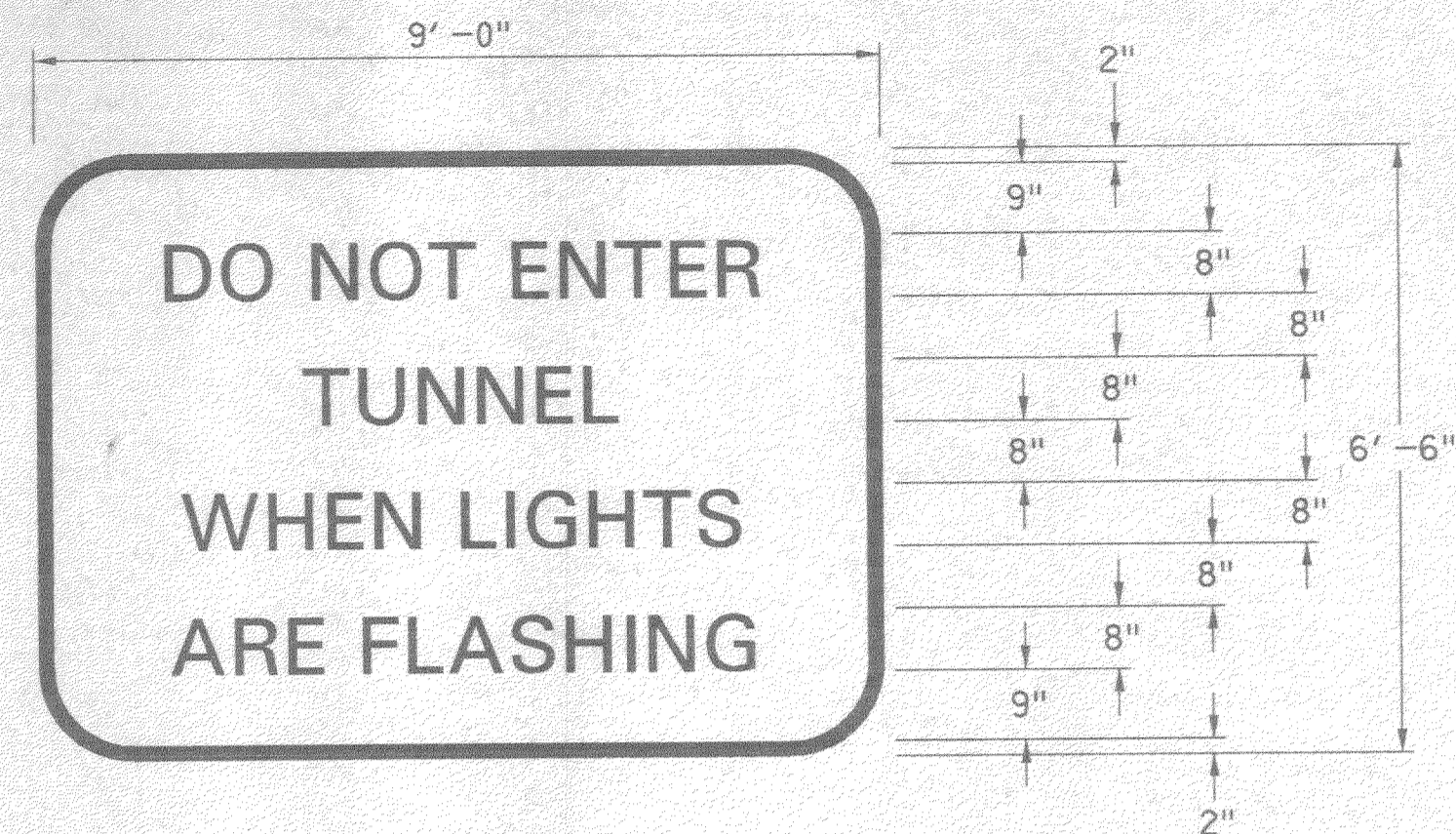

STA. 9+75  
 STA. 26+25  
 STA. 35+75

LEGEND : BLACK  
 BORDER : BLACK  
 BACKGROUND : YELLOW  
 SHEETING : HIGH REFLECTIVE (TY C)  
 BORDER RADIUS : 1'

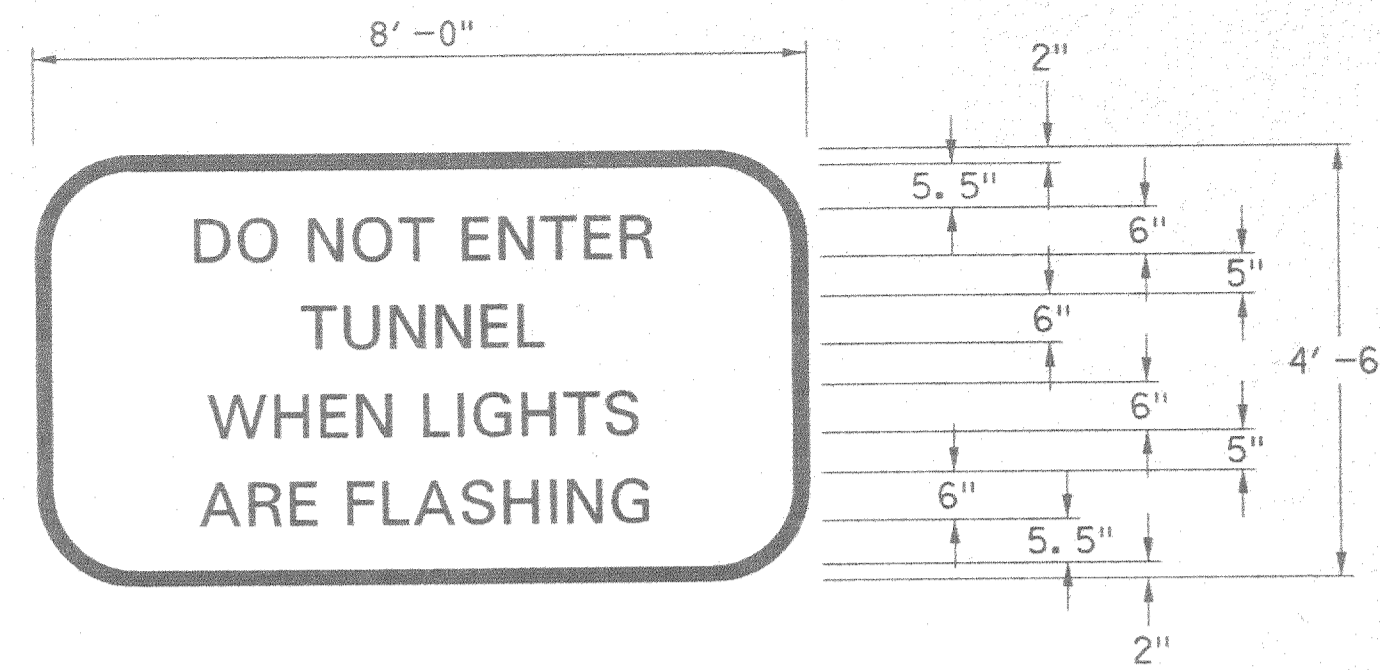

STA. 1+75

LEGEND : BLACK  
 BORDER : BLACK  
 BACKGROUND : YELLOW  
 SHEETING : HIGH REFLECTIVE (TY C)  
 BORDER RADIUS : 1'

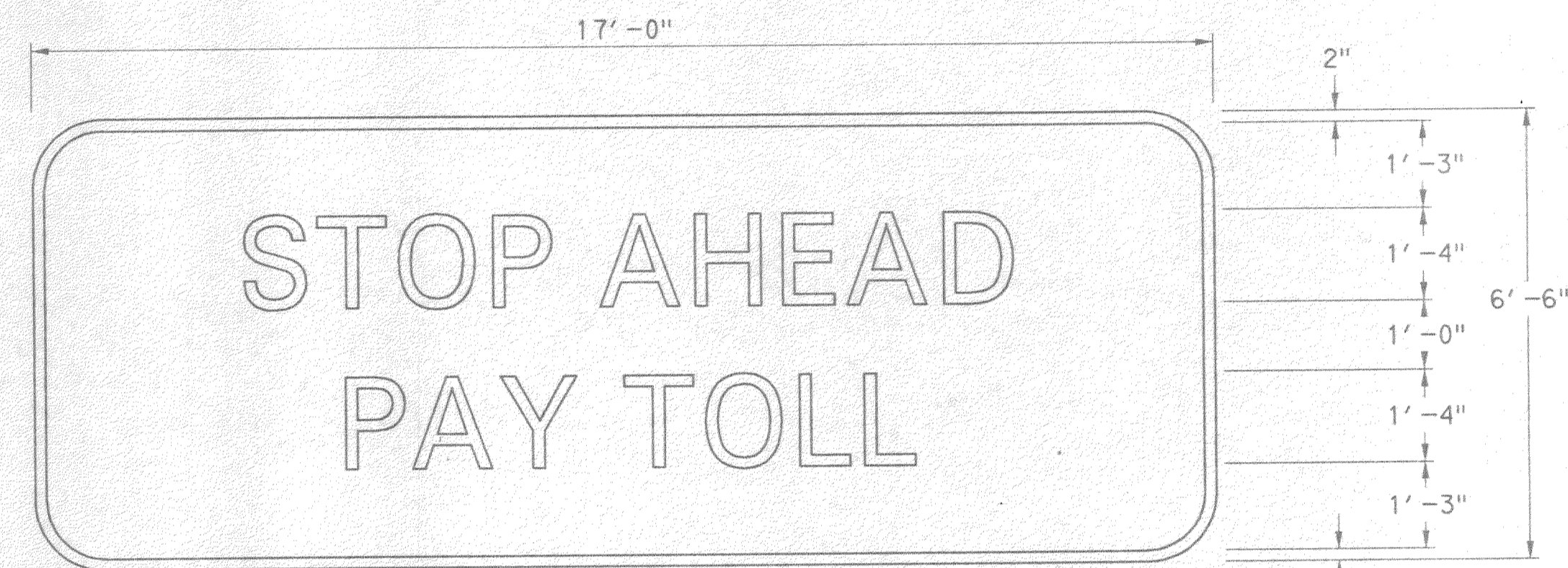

STA. 6+00

LEGEND : WHITE  
 BORDER : WHITE  
 BACKGROUND : GREEN  
 SHEETING : HIGH REFLECTIVE (TY C)  
 BORDER RADIUS : 1'

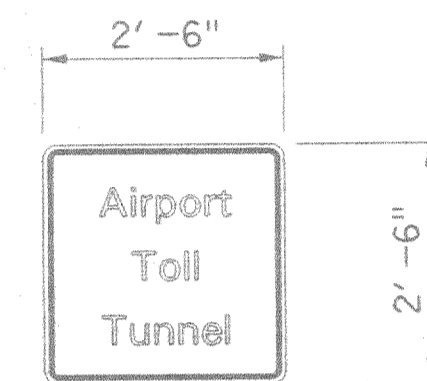

2 ON W. KELLER SPRINGS RD.  
 2 ON E. KELLER SPRINGS RD.  
 2 ON N. MIDWAY RD.  
 2 ON S. MIDWAY RD.  
 2 ON N. ADDISON RD.  
 2 ON S. ADDISON RD.

LEGEND : WHITE  
 BORDER : WHITE  
 BACKGROUND : GREEN  
 SHEETING : HIGH REFLECTIVE (TY C)

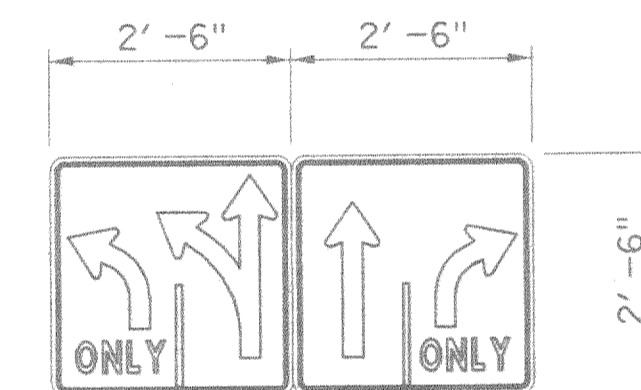

STA. 1+75

LEGEND : BLACK  
 BORDER : BLACK  
 BACKGROUND : WHITE  
 SHEETING : HIGH REFLECTIVE (TY C)

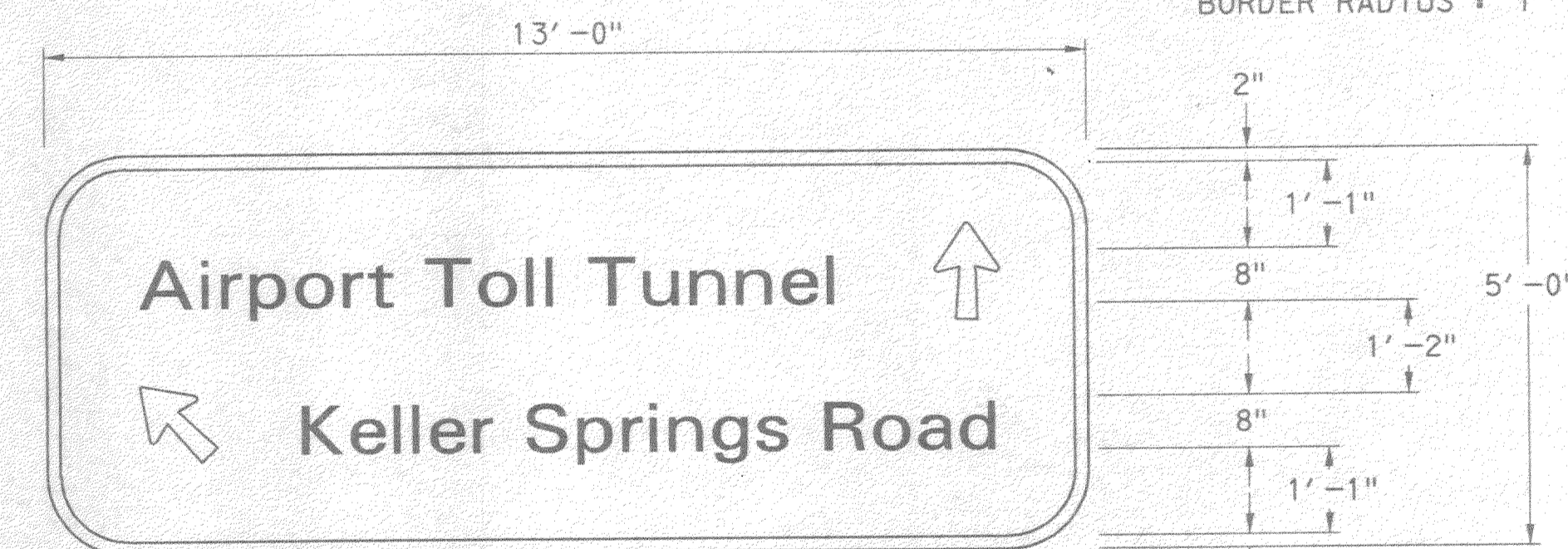

STA. 35+75

LEGEND : WHITE  
 BORDER : WHITE  
 BACKGROUND : GREEN  
 SHEETING : HIGH REFLECTIVE (TY C)  
 BORDER RADIUS : 1'

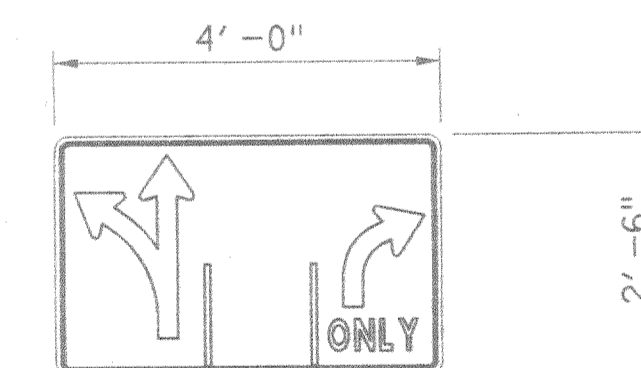

STA. 35+15

LEGEND : BLACK  
 BORDER : BLACK  
 BACKGROUND : WHITE  
 SHEETING : HIGH REFLECTIVE (TY C)

PRELIMINARY - FOR REVIEW ONLY  
 These documents are for Design Review and not intended for Construction, Bidding or Permit Purposes. They were prepared by, or under supervision of, RICHARD K. LAIRD 59187 6/13/96  
 Type of Print Name PE Date

No.	REVISION	BY	DATE
TEXAS TURNPIKE AUTHORITY ADDISON AIRPORT TUNNEL			
SIGN DETAILS			
GINN THE GINN CORPORATION			SECTION XIII
DRAWN:	DATE:	DESIGNED:	DATE:
CHECKED:	DATE:	SCALE:	1/2" = 1' + 0"
CONTRACT No. DNT-260 SHEET 6 OF 6			



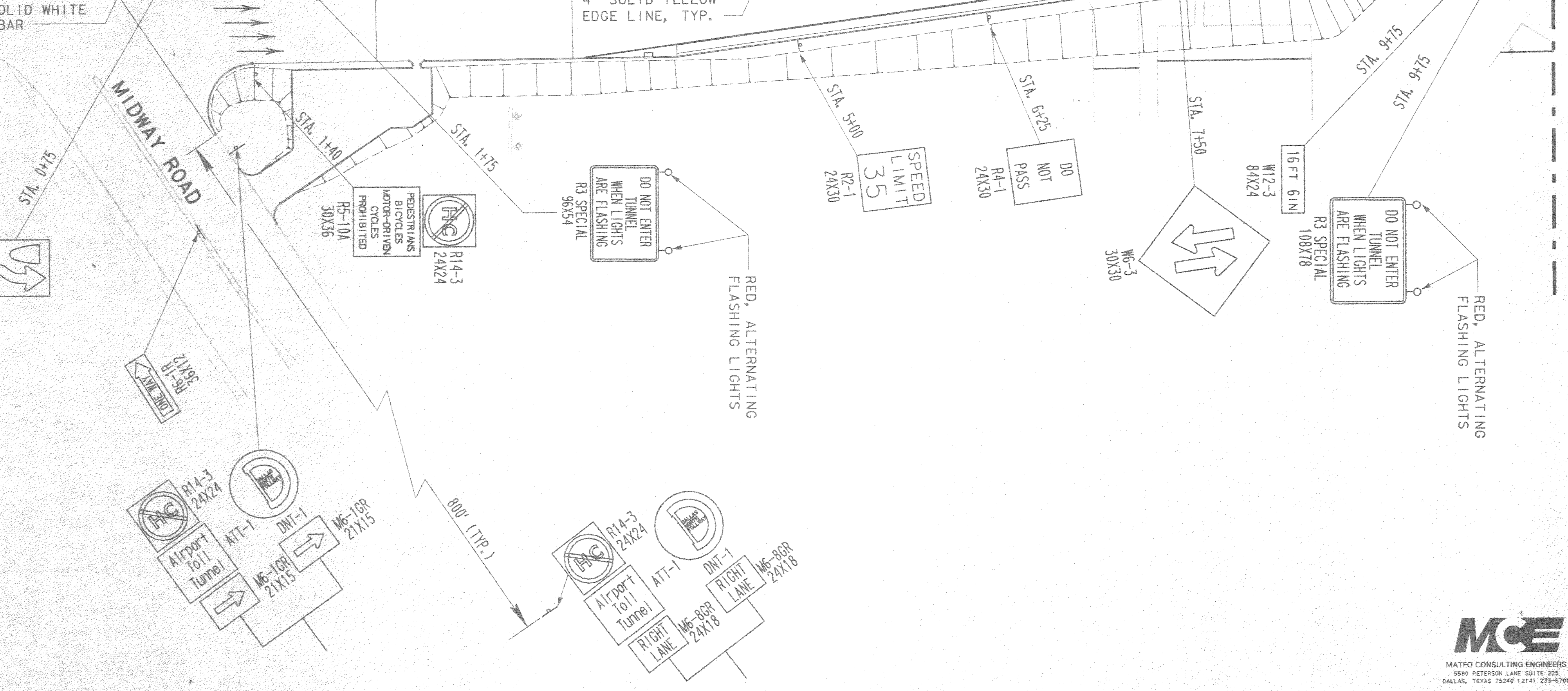
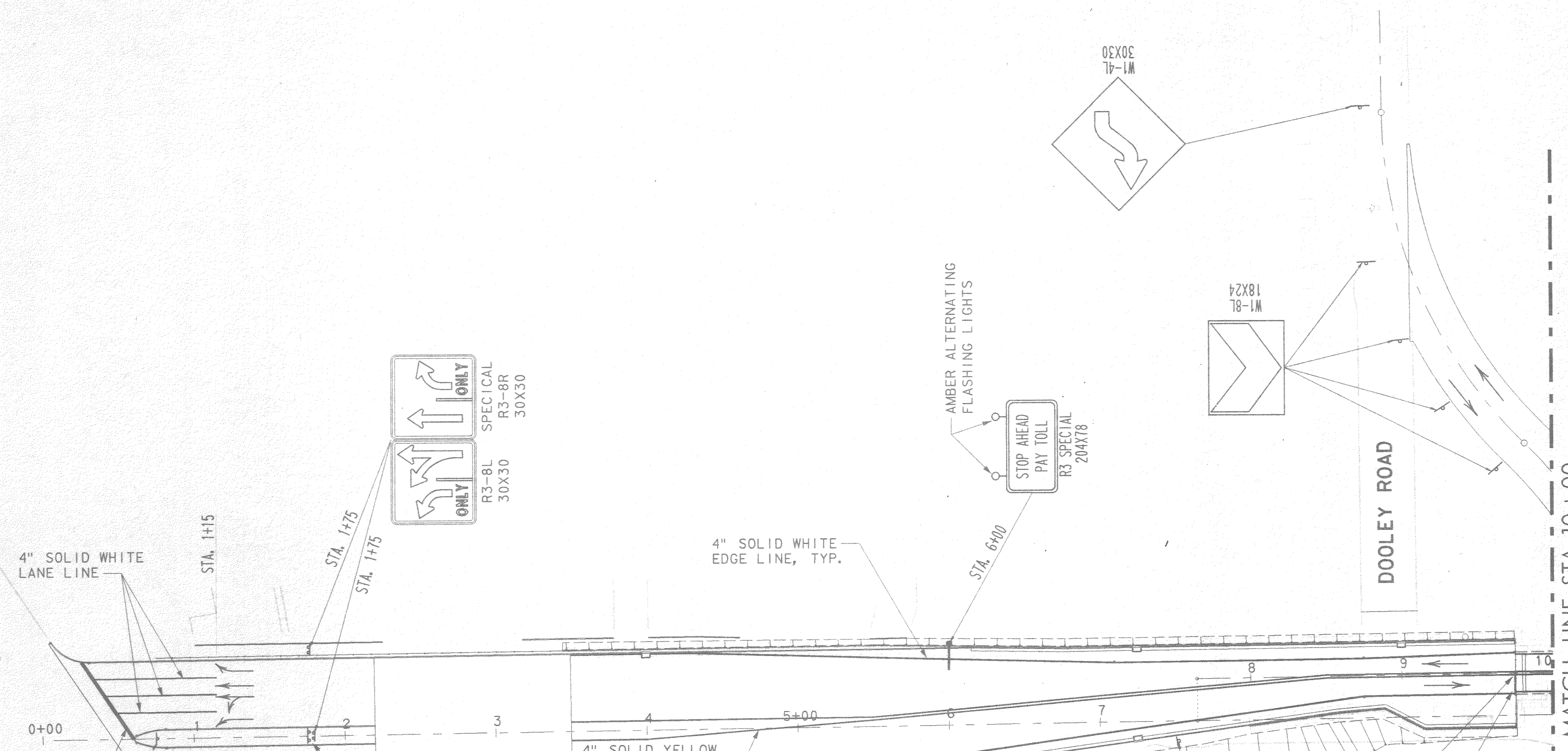
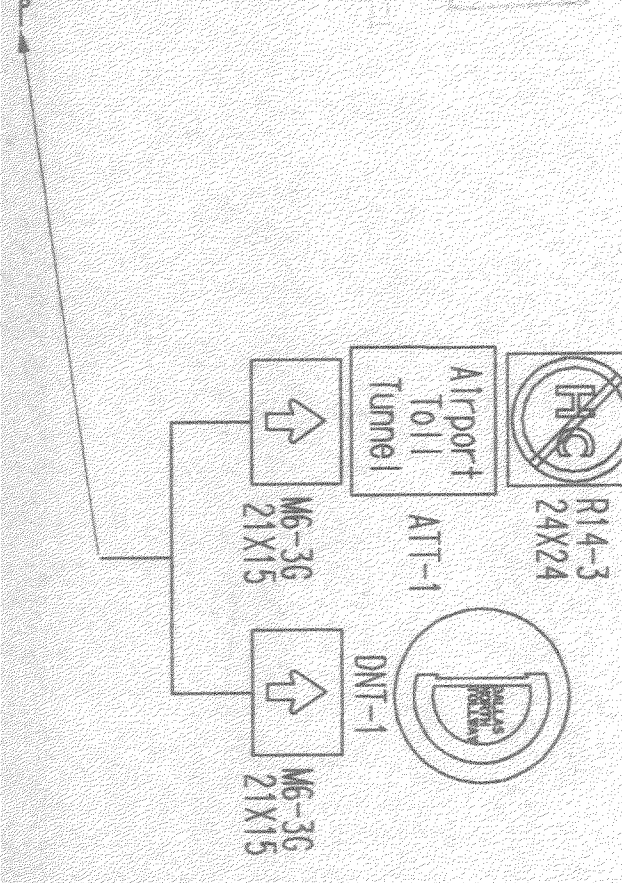
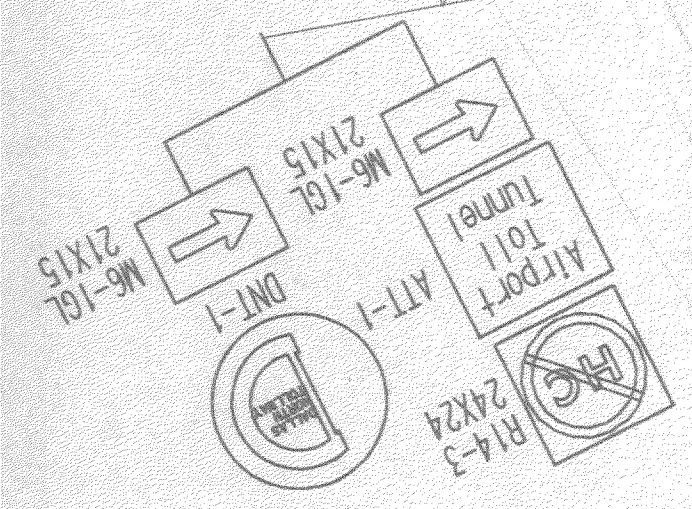
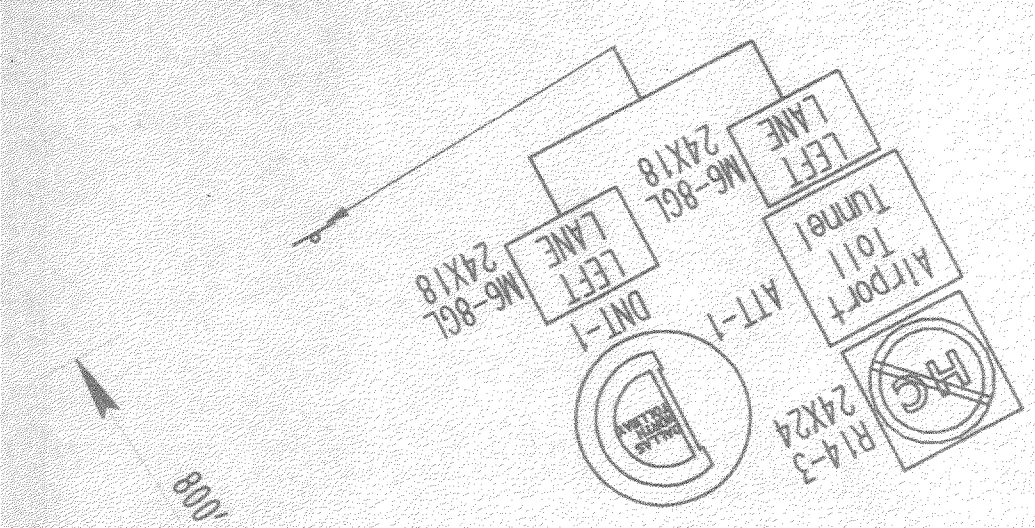
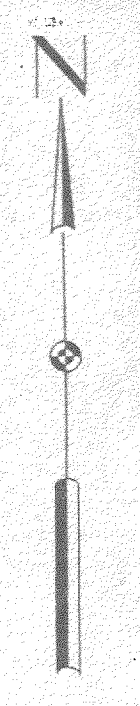

PRELIMINARY - FOR REVIEW ONLY  
These documents are for Design Review and not intended for Construction, Bidding or Permit Purposes. They were prepared by, or under supervision of, RICHARD K. LAIRD 59187 6/2/94  
Type or Print Name PE Date

No.	REVISION	BY	DATE
TEXAS TURNPIKE AUTHORITY ADDISON AIRPORT TUNNEL			
SIGNING AND PAVEMENT MARKING LAYOUT STA. 0+00 TO STA. 10+00			
GINN THE GINN CORPORATION			SECTION XIII
DRAWN	DATE	DESIGNED	DATE
CHECKED	DATE	SCALE	1" = 50'
CONTRACT No. DNT-260 SHEET 1 OF 6			

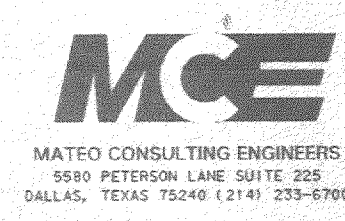

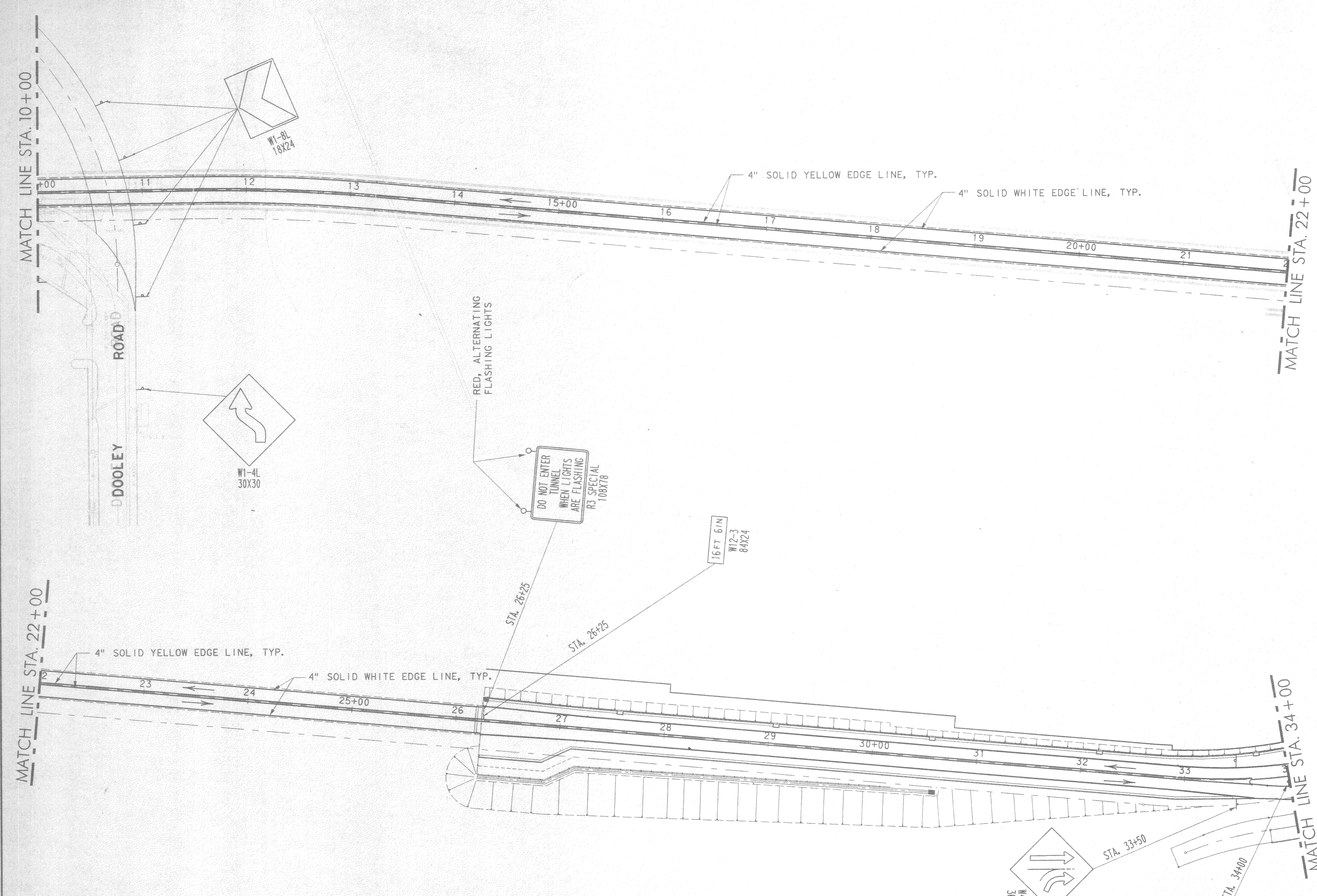

PRELIMINARY - FOR REVIEW ONLY  
 These documents are for Design Review and not intended for Construction, Bidding or Permit Purposes. They were prepared by, or under supervision of, RICHARD K. LAIRD 59187 6/13/14  
 Type or Print Name PE # Date

No.	REVISION	BY	DATE
TEXAS TURNPIKE AUTHORITY ADDISON AIRPORT TUNNEL			
SIGNING AND PAVEMENT MARKING LAYOUT STA. 10+00 TO STA. 34+00			
GINN THE GINN CORPORATION			SECTION XIII
DRAWN	DATE	DESIGNED	DATE
CHECKED	DATE	SCALE	1" = 50'
CONTRACT No. DNT-260 SHEET 2 OF 6			





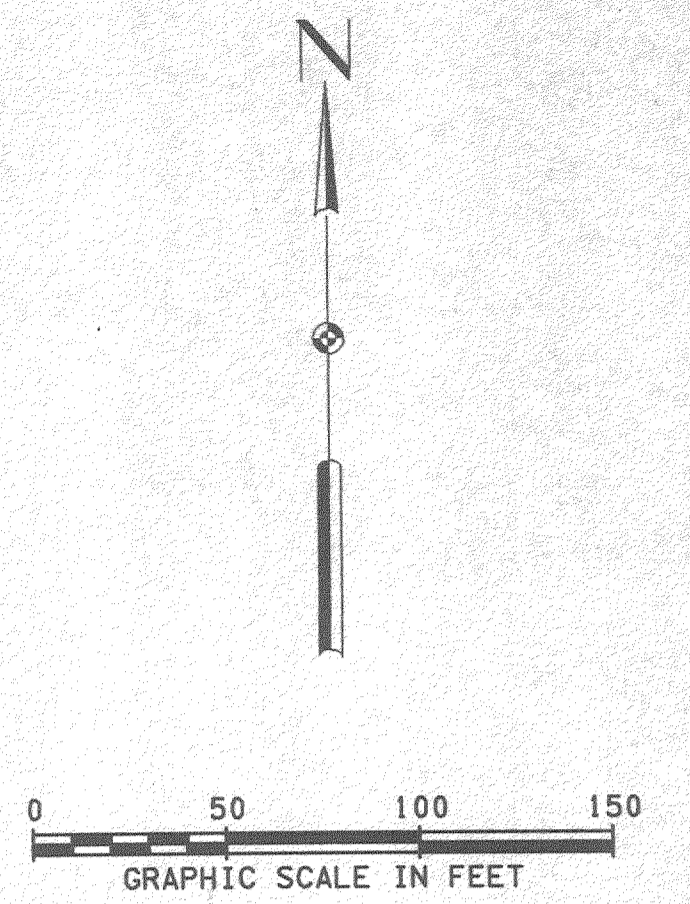
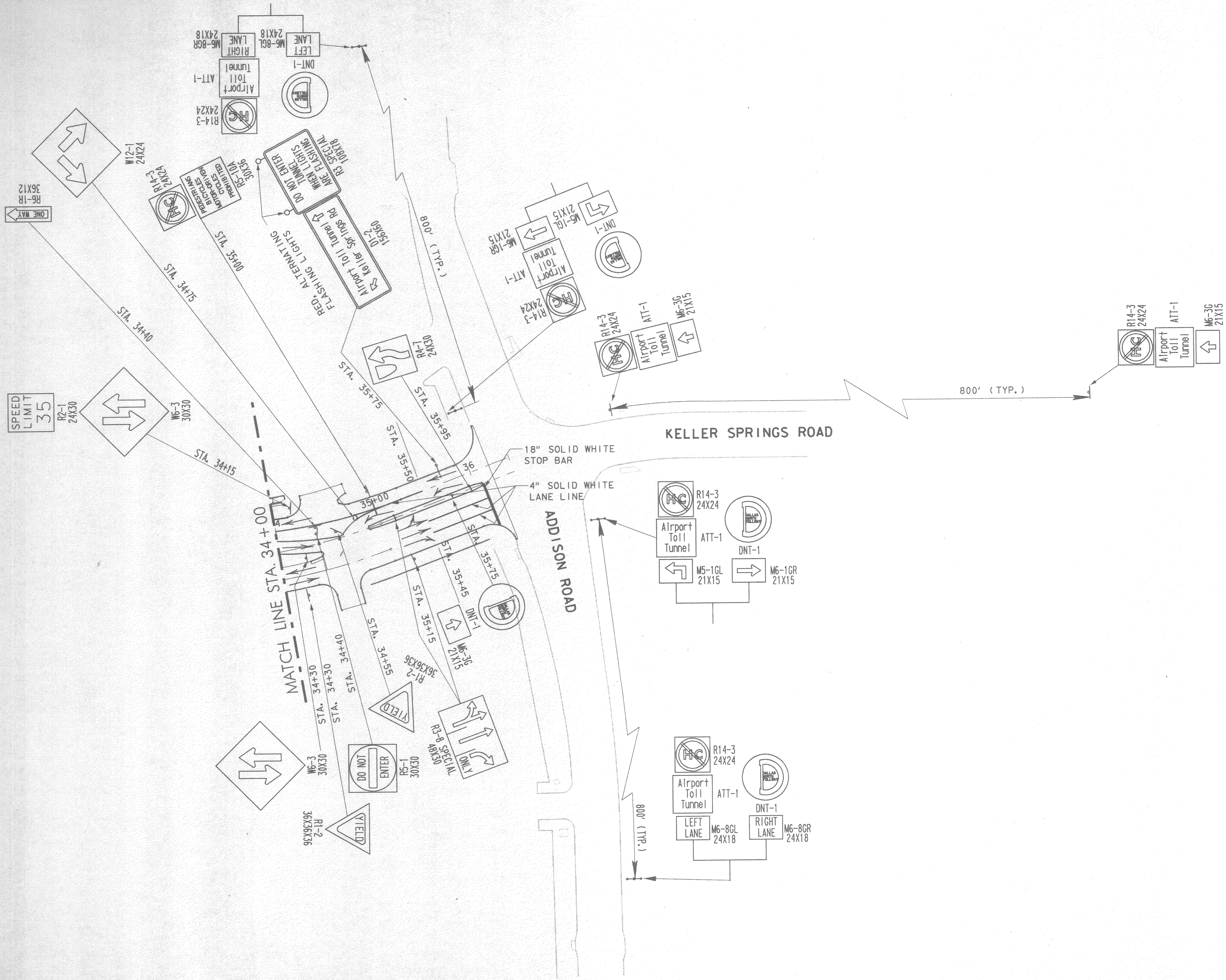

PRELIMINARY - FOR REVIEW ONLY  
 These documents are for Design Review and not intended for Construction, Bidding or Permit Purposes. They were prepared by, or under supervision of, RICHARD K. LAIRD 59187 6/13/96  
 Type or Print Name PE Date

No.	REVISION	BY	DATE
TEXAS TURNPIKE AUTHORITY ADDISON AIRPORT TUNNEL			
SIGNING AND PAVEMENT MARKING LAYOUT STA. 34+00 TO ADDISON ROAD			
GINN THE GINN CORPORATION			SECTION XIII
DRAWN	DATE	DESIGNED	DATE
CHECKED	DATE	SCALE	1" = 50'
CONTRACT No. DNT-260 SHEET 3 OF 6			



GENERAL NOTES

1. THIS OVERHEAD SIGN STRUCTURE WILL BE CONSTRUCTED WITH STEEL TOWER AND STEEL TRUSS.
2. TRUSS CONSTRUCTION SHALL CONFORM TO STANDARD SHEETS HCOSS-21, COSSD AND COSSF.
3. SIGN WALKWAY WILL BE INSTALLED ON THIS CONTRACT. SIGN, SIGN WALKWAY AND SIGN LIGHT BRACKETS, AND SIGN LIGHTS WILL ALSO BE INSTALLED UNDER THIS CONTRACT.
4. SEE STANDARD SHEETS SL (MV), SWW (1), SB (SWL-1) AND SMD (P-1) FOR ADDITIONAL INFORMATION.

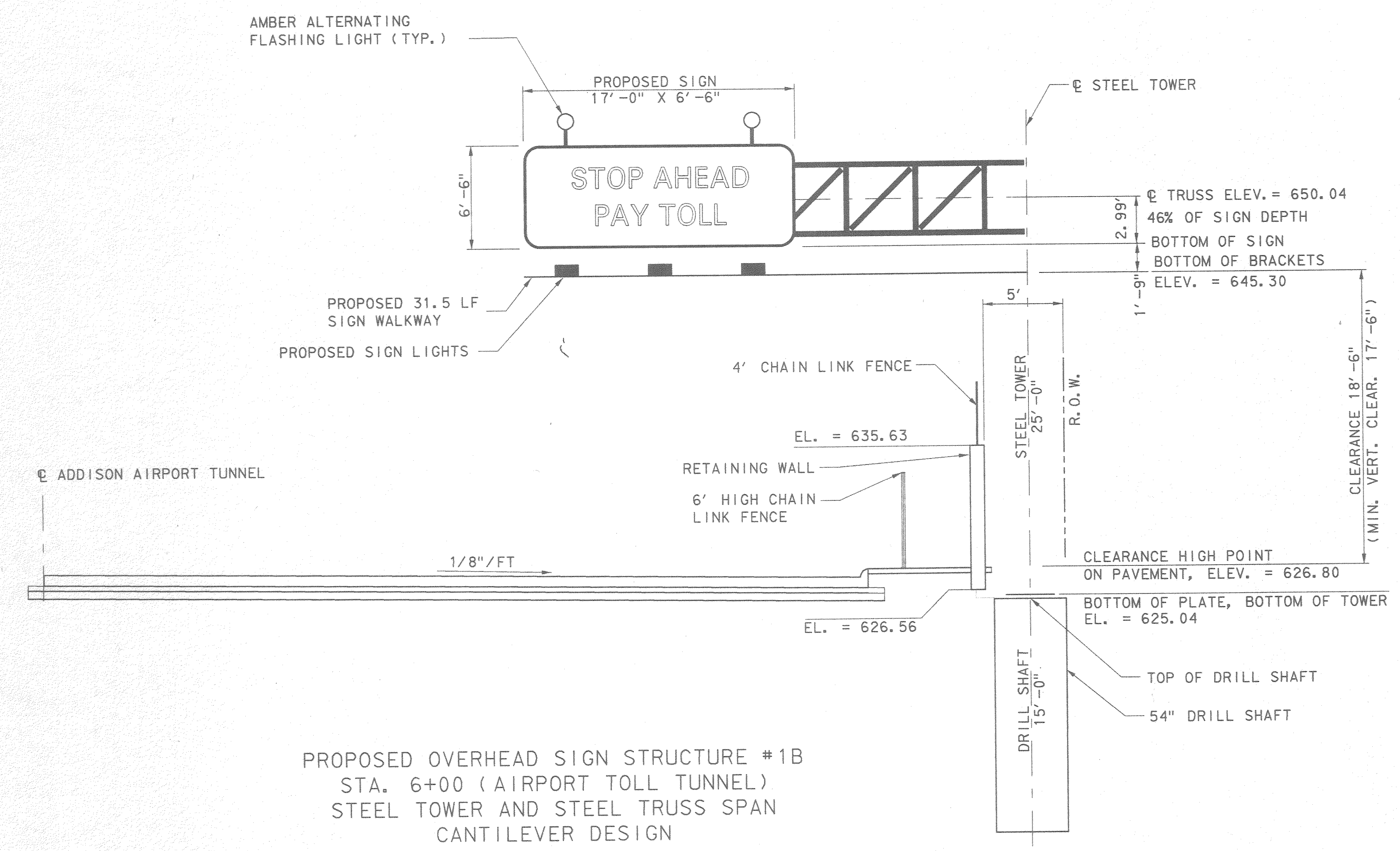

PROPOSED OVERHEAD SIGN STRUCTURE #1B  
 STA. 6+00 (AIRPORT TOLL TUNNEL)  
 STEEL TOWER AND STEEL TRUSS SPAN  
 CANTILEVER DESIGN

PRELIMINARY - FOR REVIEW ONLY  
 These documents are for Design Review and not intended for Construction, Bidding or Permit Purposes. They were prepared by, or under supervision of, RICHARD K. LAIRD 59187 6/13/26  
 Type or Print Name PE # Date

No.	REVISION	BY	DATE
TEXAS TURNPIKE AUTHORITY ADDISON AIRPORT TUNNEL			
AIRPORT TOLL TUNNEL OVERHEAD SIGN STRUCTURE #1B STA. 6+00			
GINN THE GINN CORPORATION			SECTION XIII
DRAWN: TMF	DATE:	DESIGNED: SA	DATE:
CHECKED:	DATE:	SCALE:	1"=5'-0"
CONTRACT No. DNT-260 SHEET 4 OF 6			



GENERAL NOTES:

1. THIS OVERHEAD SIGN STRUCTURE WILL BE CONSTRUCTED WITH STEEL TOWER AND STEEL TRUSS.
2. TRUSS CONSTRUCTION SHALL CONFORM TO STANDARD SHEETS HCOSS-21, COSSD AND COSSF.
3. SIGN WALKWAY WILL BE INSTALLED ON THIS CONTRACT. SIGN, SIGN WALKWAY AND SIGN LIGHT BRACKETS, AND SIGN LIGHTS WILL ALSO BE INSTALLED UNDER THIS CONTRACT.
4. SEE STANDARD SHEETS SL (MV), SWW (1), SB (SWL-1) AND SMD (P-1) FOR ADDITIONAL INFORMATION.

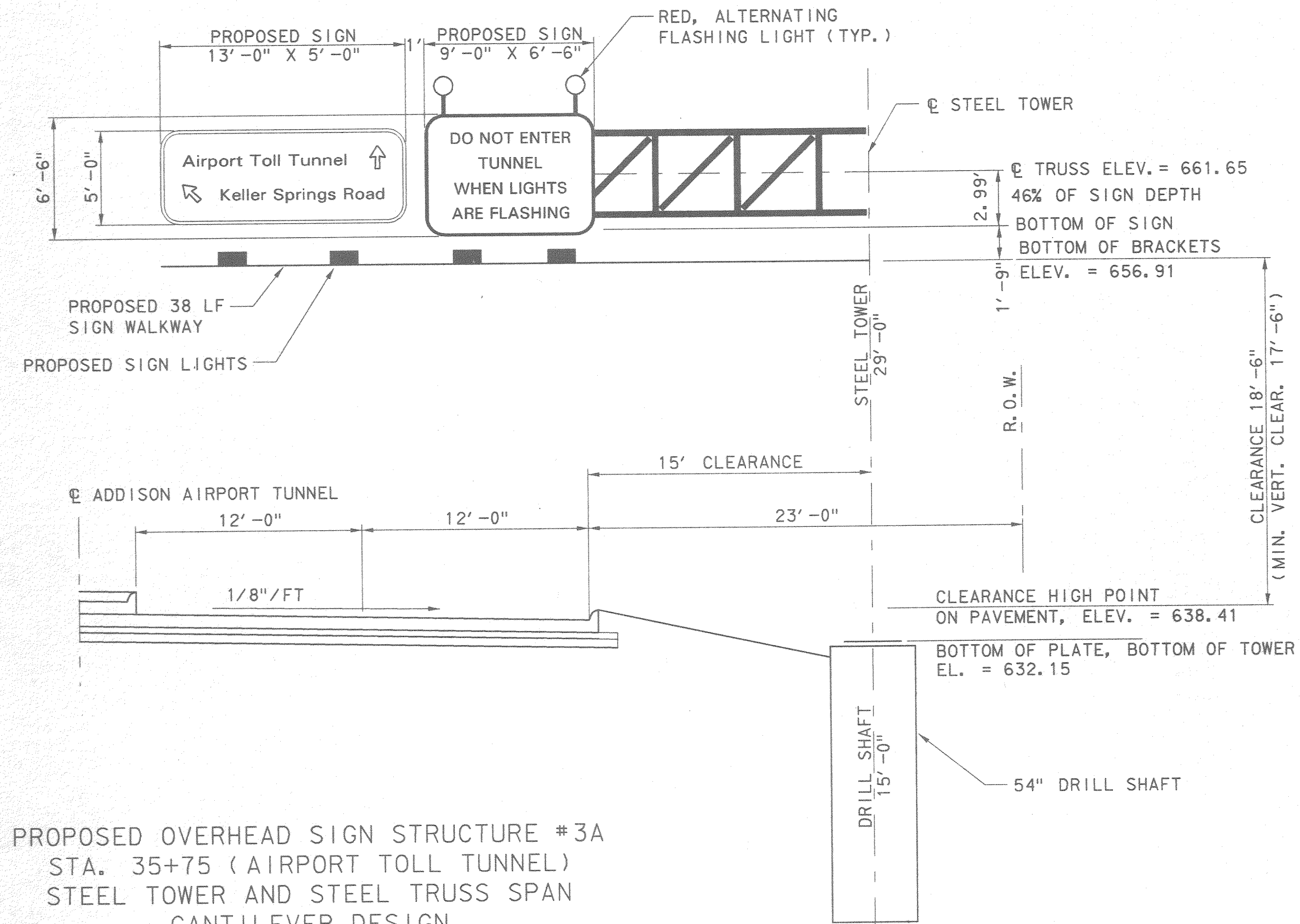

PROPOSED OVERHEAD SIGN STRUCTURE #3A  
 STA. 35+75 (AIRPORT TOLL TUNNEL)  
 STEEL TOWER AND STEEL TRUSS SPAN  
 CANTILEVER DESIGN

PRELIMINARY - FOR REVIEW ONLY

These documents are for Design Review and not intended for Construction, Bidding or Permit Purposes. They were prepared by, or under supervision of:  
 RICHARD K. LAIRD 59187 6/18/96  
 Type or Print Name PE # Date



No.	REVISION	BY	DATE
TEXAS TURNPIKE AUTHORITY ADDISON AIRPORT TUNNEL			
AIRPORT TOLL TUNNEL OVERHEAD SIGN STRUCTURE #3A STA. 35+75			
GINN THE GINN CORPORATION			SECTION XIII
DRAWN: JMF	DATE:	DESIGNED: SA	DATE:
CHECKED:	DATE:	SCALE:	1"=5'-0"
CONTRACT No. DNT-260 SHEET 5 OF 6			

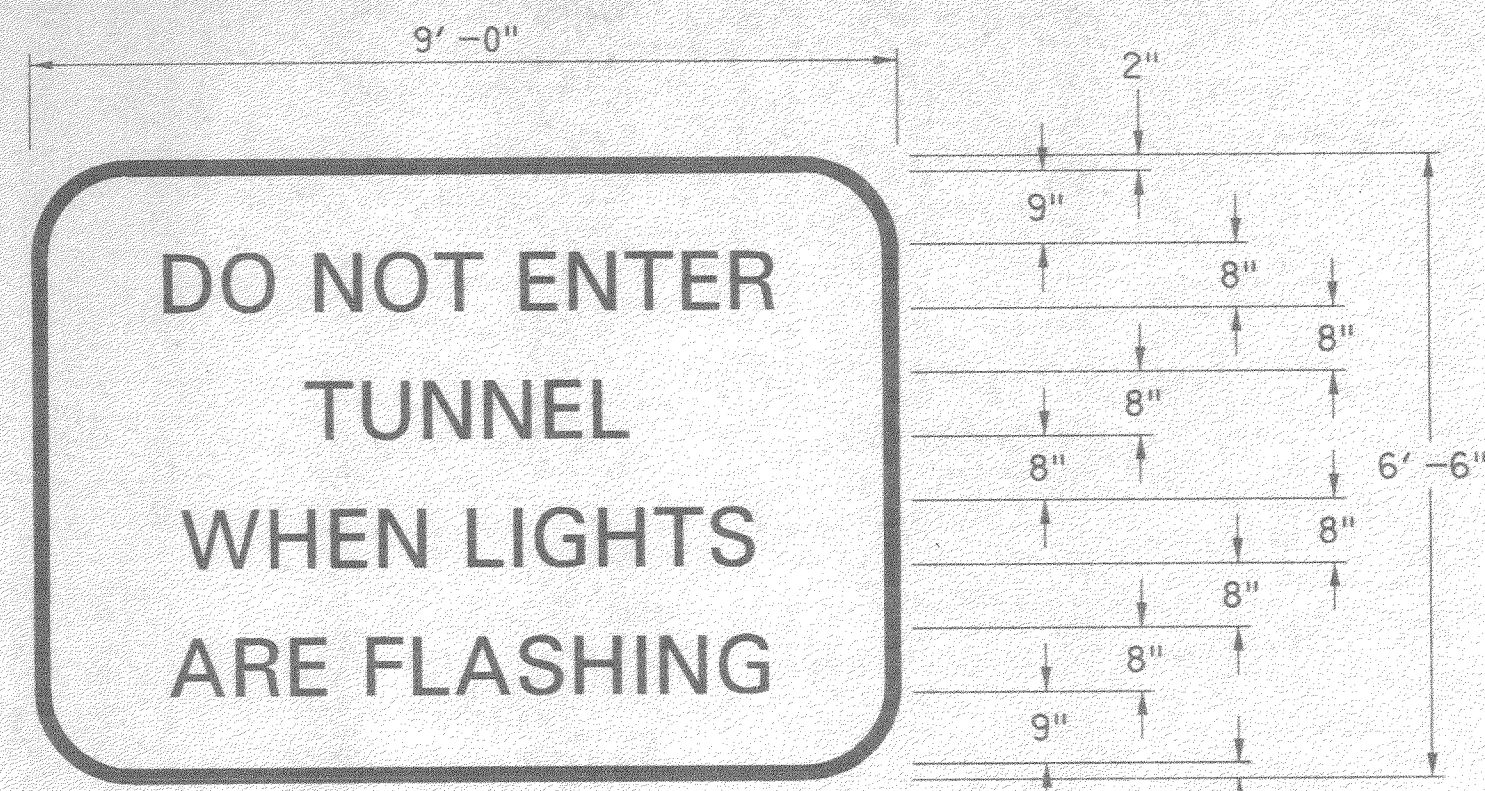

STA. 9+75  
 STA. 26+25  
 STA. 35+75

LEGEND : BLACK  
 BORDER : BLACK  
 BACKGROUND : YELLOW  
 SHEETING : HIGH REFLECTIVE (TY C)  
 BORDER RADIUS : 1'

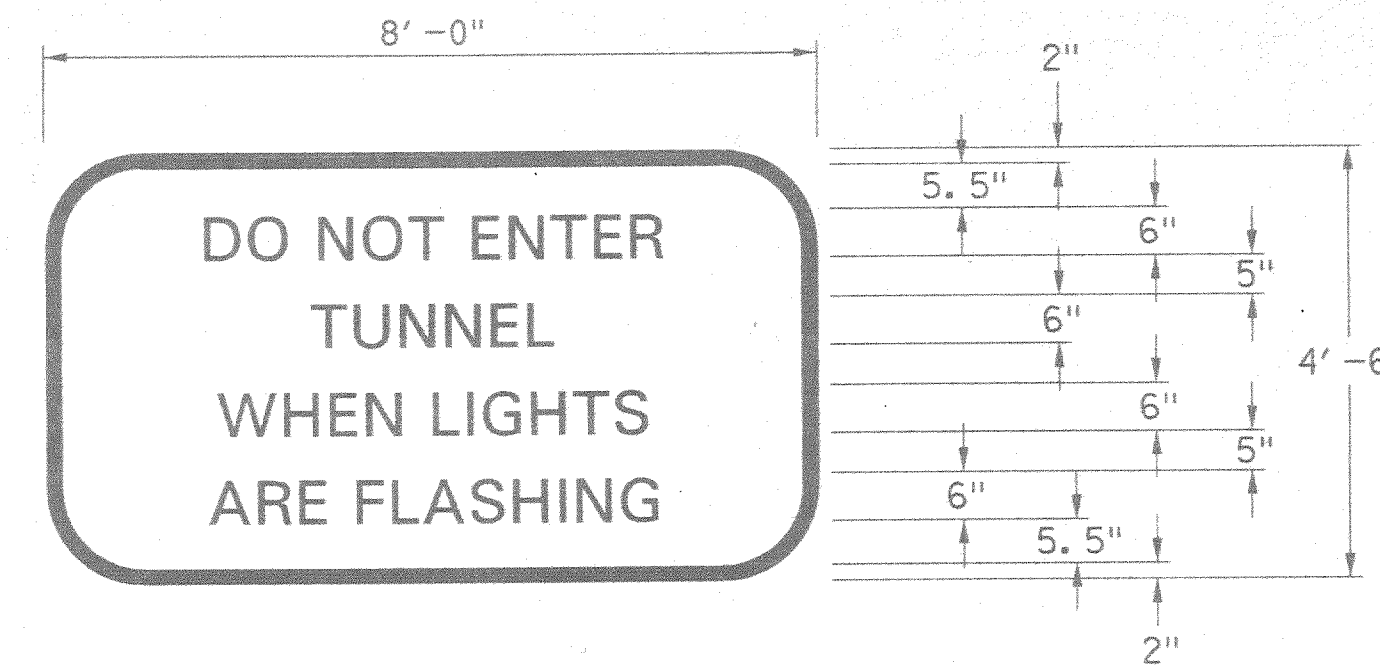

STA. 1+75

LEGEND : BLACK  
 BORDER : BLACK  
 BACKGROUND : YELLOW  
 SHEETING : HIGH REFLECTIVE (TY C)  
 BORDER RADIUS : 1'

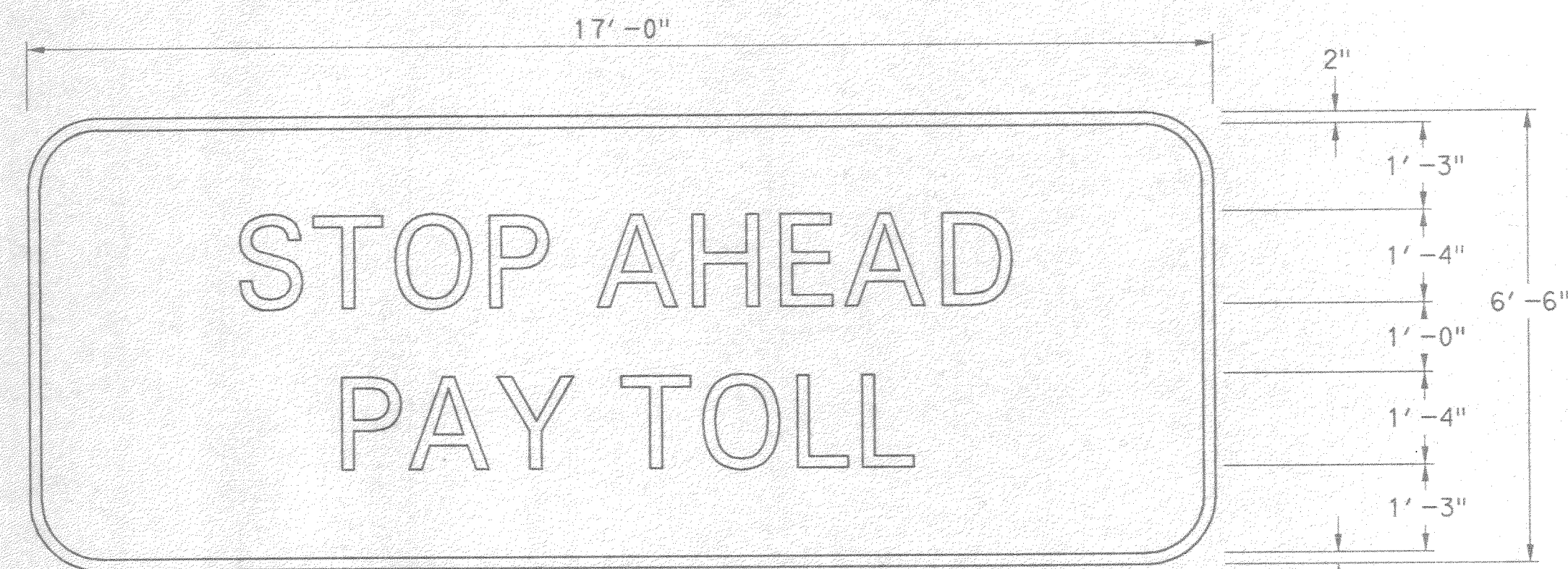

STA. 6+00

LEGEND : WHITE  
 BORDER : WHITE  
 BACKGROUND : GREEN  
 SHEETING : HIGH REFLECTIVE (TY C)  
 BORDER RADIUS : 1'

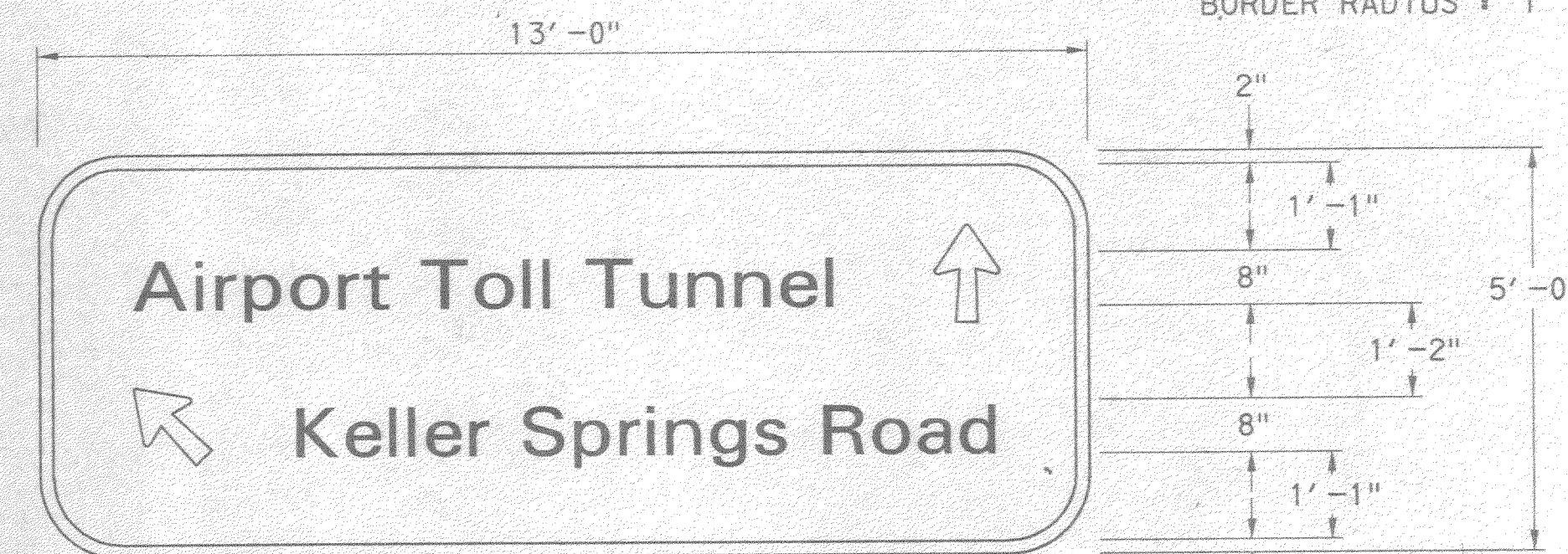

STA. 35+75

LEGEND : WHITE  
 BORDER : WHITE  
 BACKGROUND : GREEN  
 SHEETING : HIGH REFLECTIVE (TY C)  
 BORDER RADIUS : 1'

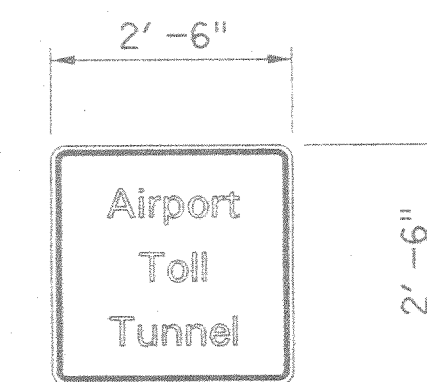

2 ON W. KELLER SPRINGS RD.  
 2 ON E. KELLER SPRINGS RD.  
 2 ON N. MIDWAY RD.  
 2 ON S. MIDWAY RD.  
 2 ON N. ADDISON RD.  
 2 ON S. ADDISON RD.

LEGEND : WHITE  
 BORDER : WHITE  
 BACKGROUND : GREEN  
 SHEETING : HIGH REFLECTIVE (TY C)

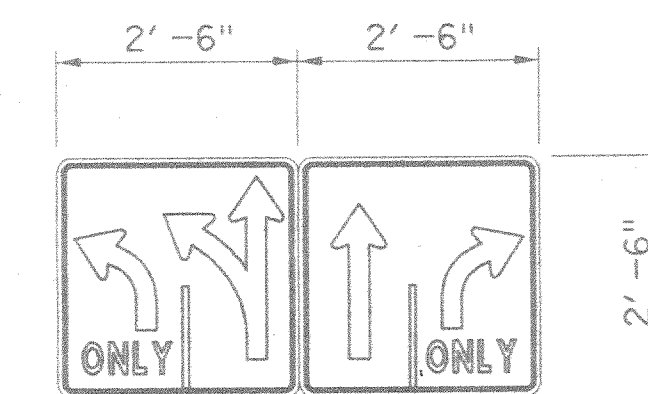

STA. 1+75

LEGEND : BLACK  
 BORDER : BLACK  
 BACKGROUND : WHITE  
 SHEETING : HIGH REFLECTIVE (TY C)

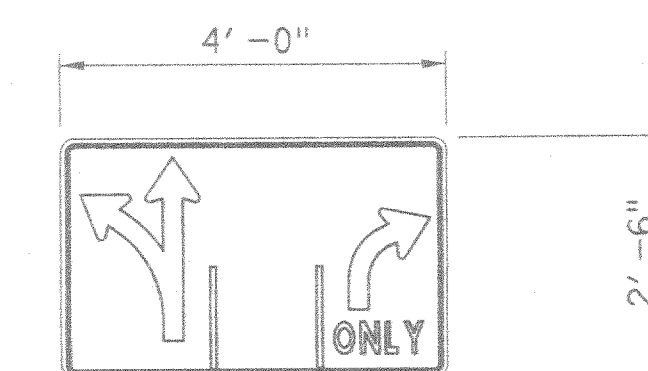

STA. 35+15

LEGEND : BLACK  
 BORDER : BLACK  
 BACKGROUND : WHITE  
 SHEETING : HIGH REFLECTIVE (TY C)

PRELIMINARY - FOR REVIEW ONLY  
 These documents are for Design Review and not intended for Construction, Bidding or Permit Purposes. They were prepared by, or under supervision of, RICHARD K. LAIRD 59187 6/13/96  
 Type or Print Name PE Date

No.	REVISION	BY	DATE
TEXAS TURNPIKE AUTHORITY ADDISON AIRPORT TUNNEL			
SIGN DETAILS			
GINN THE GINN CORPORATION			SECTION XIII
DRAWN:	DATE:	DESIGNED:	DATE:
CHECKED:	DATE:	SCALE:	1/2" = 1'-0"
CONTRACT No. DNT-260 SHEET 6 OF 6			

