

DISCLAIMER
The use of this standard is governed by the "Texas Engineering Practice Act". No warranty of any kind is made by TxDOT for any purpose whatsoever. TxDOT assumes no responsibility for the conversion of this standard to other formats or for incorrect results or damages resulting from its use.

DATE:	16
CK:	15
DVI:	14
CK:	13
FILE:	12
	11
	10
	9
	8
	7
	6
	5
	4
	3
	2
	1

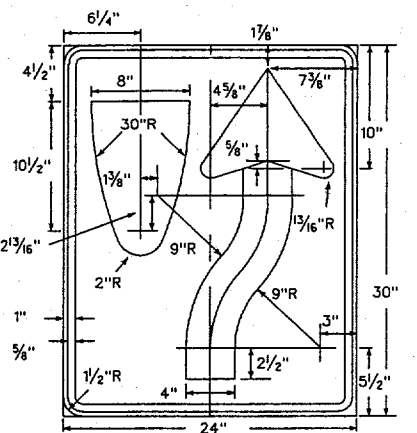

R4-7 Symbol - Black
(R4-8) Border - Black
24" X 30" Background - White Refl.

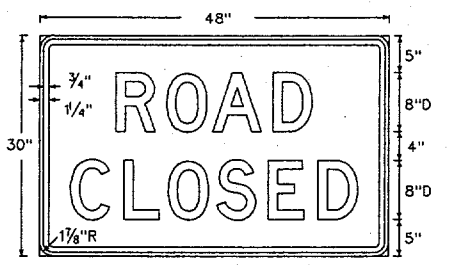

R11-2 Letters - Black
Border - Black
48" X 30" Background - White Refl.

Alternate 1st line legend
STREET ^{8"D} **R11-2S**
RAMP ^{8"D} **R11-2R**
BRIDGE ^{8"D} **R11-2B**

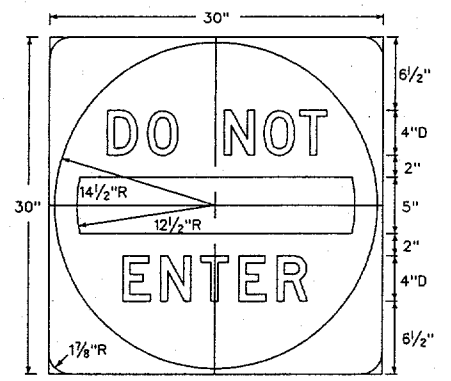

R5-1 Letters - White Refl.
Bar - White Refl.
Border - White Refl.
30" X 30" Background - Red Refl.

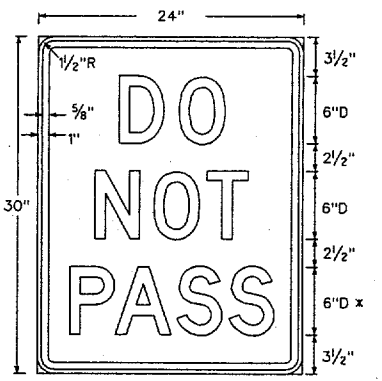

R4-1 Letters - Black
Border - Black
24" X 30" Background - White Refl.
x reduce spacing 40%

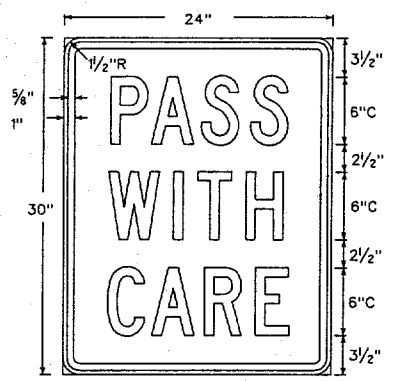

R4-2 Letters - Black
Border - Black
24" X 30" Background - White Refl.

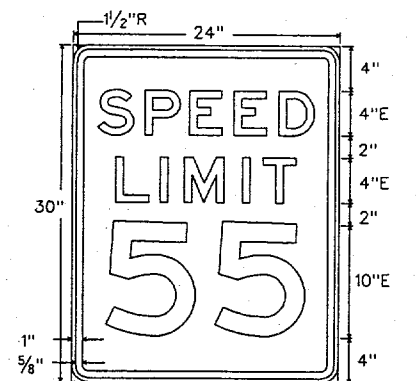

R2-1 Letters - Black
Border - Black
24" X 30" Background - White Refl.

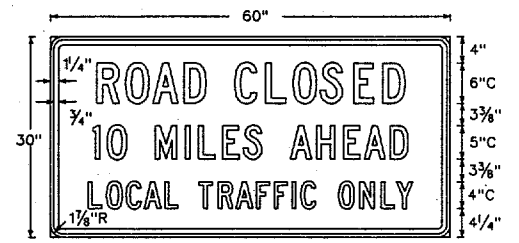

R11-3a Letters - Black
Numerals - Black
Border - Black
60" X 30" Background - White Refl.

Alternate 1st line legend
BRIDGE OUT ^{6"C} **R11-3b**

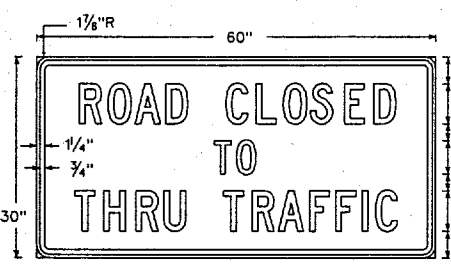

R11-4 Letters - Black
Border - Black
60" X 30" Background - White Refl.

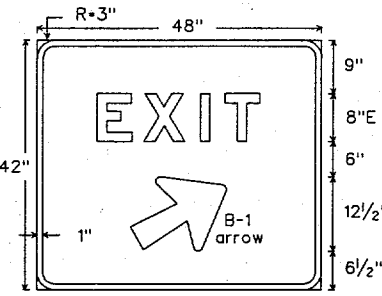

E5-1a Letters - White Refl.
Numerals - White Refl.
Symbol - White Refl.
48" X 42" Background - Green Refl.

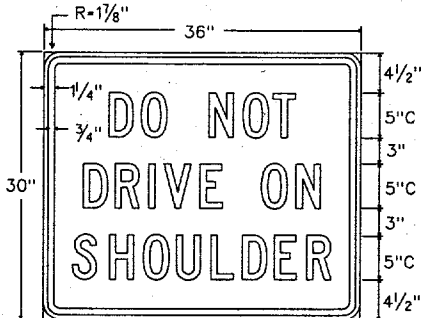

R4-3a Letters - Black
Border - Black
36" X 30" Background - White Refl.

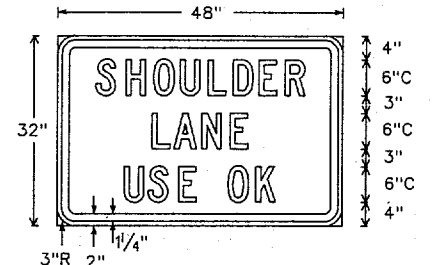

R4-3d Letters - Black
Border - Black
48" X 32" Background - White Refl.

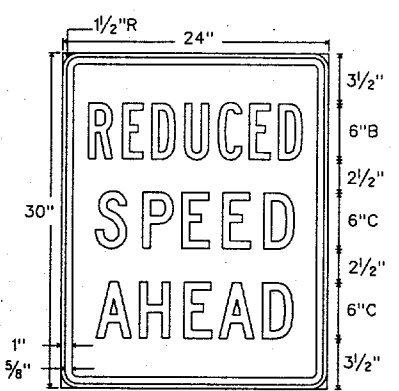

R2-5a Letters - Black
Border - Black
24" X 30" Background - White Refl.

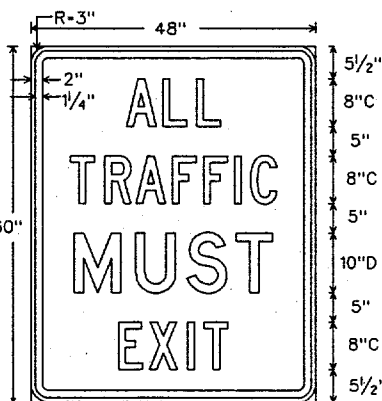

R3-22 Letters - Black
Border - Black
48" X 60" Background - White Refl.

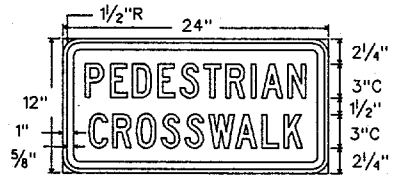

R5-7 Letters - Black
Border - Black
24" X 12" Background - White Refl.

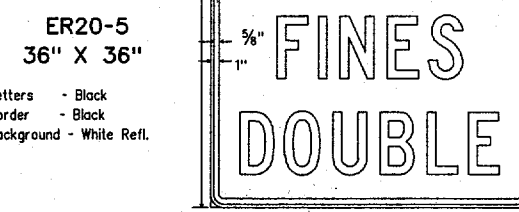

ER20-5 Letters - Black
Border - Black
36" X 36" Background - White Refl.

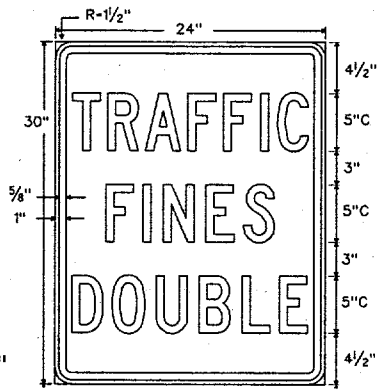

R20-5 Letters - Black
Border - Black
24" X 30" Background - White Refl.

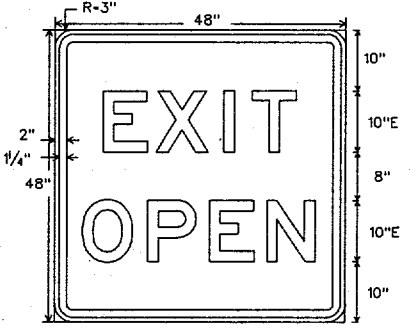

E5-2 Letters - Black
Border - Black
48" X 48" Background - Orange Refl.

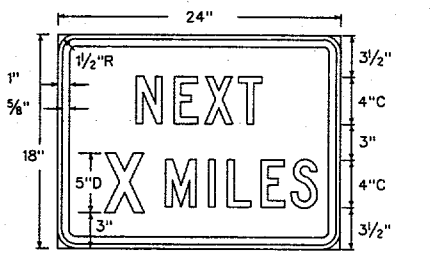

R20-1 Letters - Black
Border - Black
24" X 18" Background - White Refl.

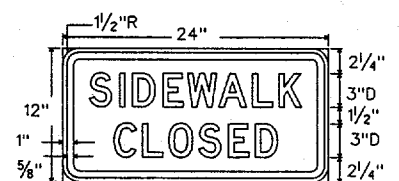

R5-8 Letters - Black
Border - Black
24" X 12" Background - White Refl.

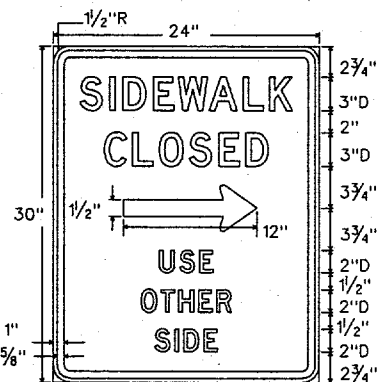

R5-8T Letters - Black
Symbol - Black
Border - Black
24" X 30" Background - White Refl.

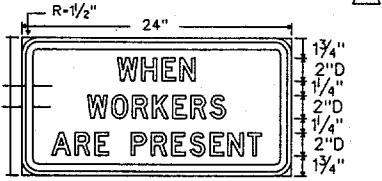

R20-5 Letters - Black
Border - Black
24" X 12" Background - White Refl.

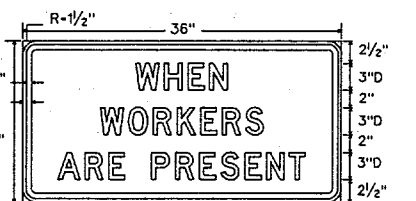

ER20-5 Letters - Black
Border - Black
36" X 18" Background - White Refl.

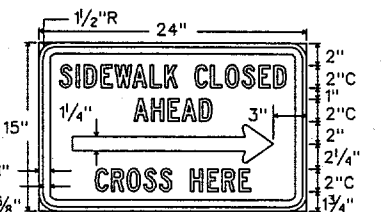

R5-9a Letters - Black
Symbol - Black
Border - Black
24" X 15" Background - White Refl.

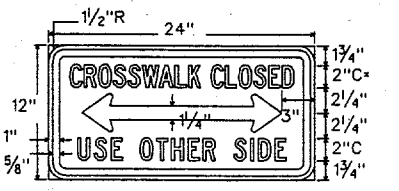

R5-9 Letters - Black
Symbol - Black
Border - Black
24" X 12" Background - White Refl.

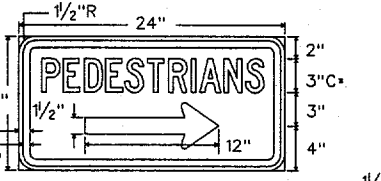

R5-7T Letters - Black
Symbol - Black
Border - Black
24" X 12" Background - White Refl.

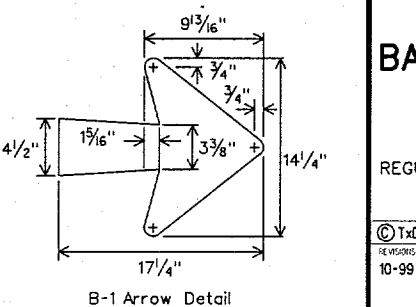
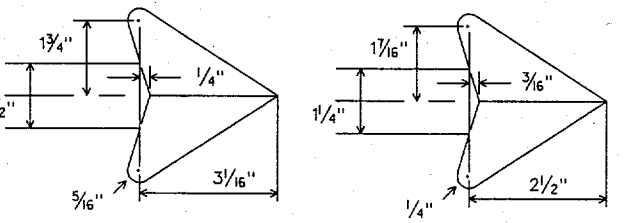

B-1 Arrow Detail

STANDARD PLANS
TEXAS DEPARTMENT OF TRANSPORTATION
Traffic Operations Division

BARRICADE AND CONSTRUCTION STANDARDS

REGULATORY AND GUIDE SIGNS **BC(9)-99**

10/99 Revision
▲ Added new sign

REVISION	DATE	BY	CHKD	DESCRIPTION
10-99	February 1998	GB	DTN	DTN
6				