

DISCLAIMER
 This standard is governed by the "Texas Engineering Practice Act". No warranty of any kind is made by TxDOT for any purpose whatsoever. TxDOT assumes no responsibility for the conversion of this standard to other formats or for incorrect results or damages resulting from its use.

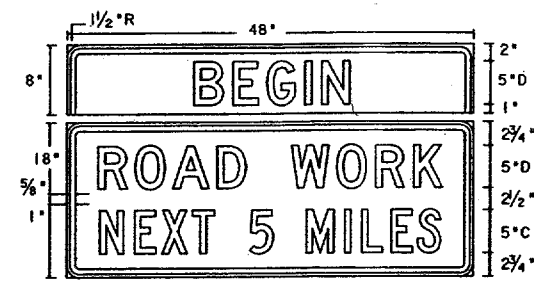

SG20-1 w/plaque
 48" X 26"
 Letters - Black
 Numbers - Black
 Border - Black
 Background - Orange Refl.

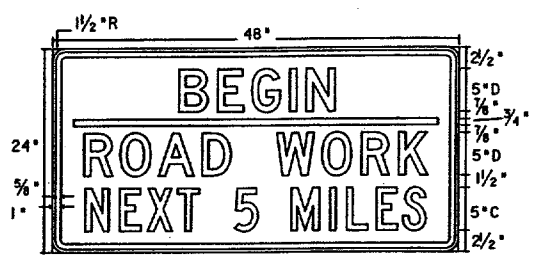

SG20-5T
 48" X 24"
 Letters - Black
 Numbers - Black
 Border - Black
 Background - Orange Refl.

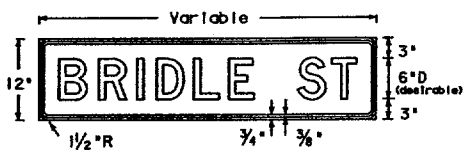

M4-9N
 Variable X 12"
 Letters - Black
 Border - Black
 Background - Orange Refl.

The M4-9R, L or S sign is to be used to detour local streets or roads that are not a State or Federal numbered highway, however, it should not be used in lieu of the M4-10 sign at the beginning of the detour or to detour State or Federal numbered routes. Also, when the M4-9R, L or S sign is used, a sign (M4-9N) with the name of the street being detoured may be mounted above it.

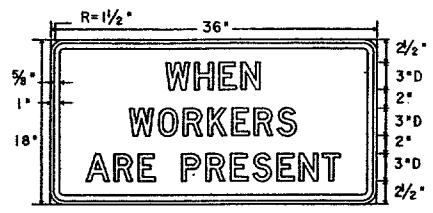

ER20-5
 Plaque
 36" X 18"
 Letters - Black
 Border - Black
 Background - White Refl.

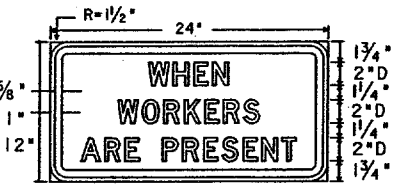

R20-5
 Plaque
 24" X 12"
 Letters - Black
 Border - Black
 Background - White Refl.

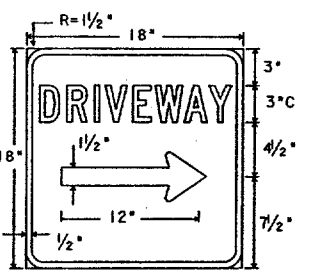

D-70a
 18" X 18"
 Letters - White Refl.
 Symbol - White Refl.
 Border - White Refl.
 Background - Blue Refl.

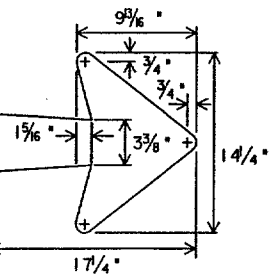
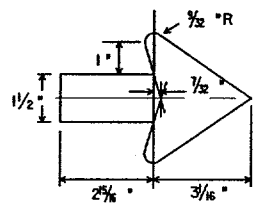

B-1 Arrow Detail



D-70S
 42" X 14"
 Letters - White Refl.
 Symbol - White Refl.
 Border - White Refl.
 Background - Blue Refl.

* Alternate first line legend for D-70S

- RESTAURANT | D70R 4°C
- BUSINESS | D70B 4°C
- MOTEL | D70M 4°C
- GAS | D70G 4°C

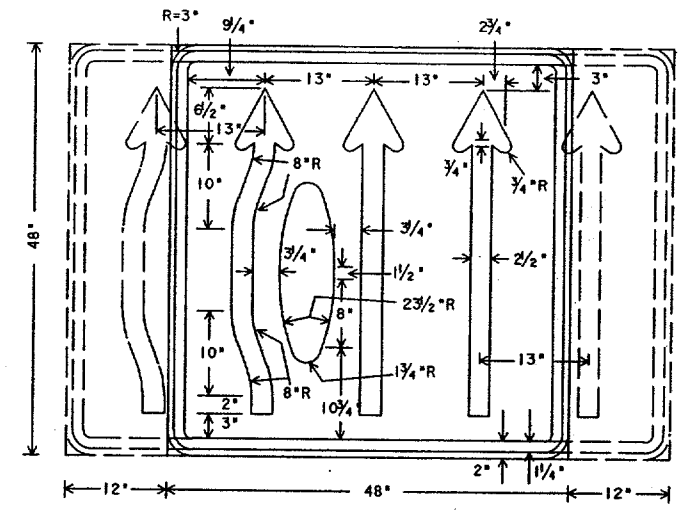

CW24-2
 Var. X 48"
 A mirror image may be used to show proper lane alignment.

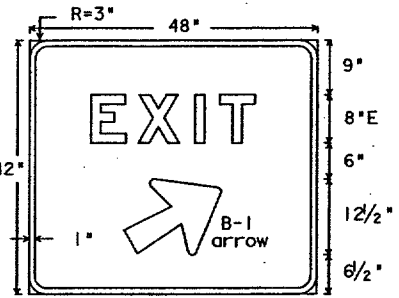

E5-1a
 48" X 42"
 Letters - White Refl.
 Arrow - White Refl.
 Border - White Refl.
 Background - Green Refl.

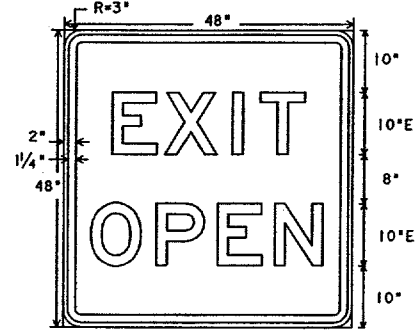

E5-2
 48" X 48"
 Letters - Black
 Border - Black
 Background - Orange Refl.

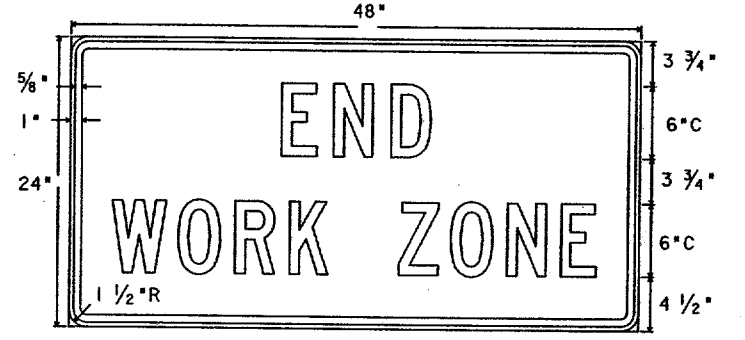

G20-2b
 48" X 24"
 Letters - Black
 Border - Black
 Background - Orange Refl.

DEPARTMENT MATERIAL SPECIFICATIONS			
PLYWOOD SIGN BLANKS			DMS-7100
ALUMINUM SIGN BLANKS			DMS-7110
FLAT SURFACE REFLECTIVE SHEETING			DMS-8300
VINYL NON-REFLECTIVE DECAL SHEETING			DMS-8320
REFLECTIVE SHEETING OR OTHER MATERIAL			
COLOR	USAGE		
BLUE	BACKGROUND	TYPE C (HIGH SPECIFIC INTENSITY)	
RED	BACKGROUND	TYPE C (HIGH SPECIFIC INTENSITY)	
GREEN	BACKGROUND	TYPE C (HIGH SPECIFIC INTENSITY)	
ORANGE	BACKGROUND	TYPE E (FLUORESCENT PRISMATIC)	
WHITE	BACKGROUND	TYPE C (HIGH SPECIFIC INTENSITY)	
YELLOW	BACKGROUND	TYPE C (HIGH SPECIFIC INTENSITY)	
BLACK	LEGEND & BORDERS	VINYL NON-REFLECTIVE DECAL SHEETING	
WHITE	LEGEND & BORDERS	TYPE C (HIGH SPECIFIC INTENSITY)	

Only pre-qualified products shall be used. A copy of the "Compliant Work Zone Traffic Control Devices List" (CWZTCD) describes pre-qualified products and their sources and may be obtained by contacting:

Standards Engineer
 Traffic Operations Division - TE
 Texas Department of Transportation
 125 East 11th Street
 Austin, Texas 78701-2483
 Phone (512) 416-3120
 Fax (512) 416-3299

Instructions to locate the "CWZTCD" on TxDOT website are:

Start at website - www.dot.state.tx.us
 Click on "About TxDOT",
 Click on "Functional Organizational Chart",
 Click on Traffic Operations Box,
 Click on "Compliant Work Zone Traffic Control Devices",
 again click on "Compliant Work Zone Traffic Control Devices".
 This site is printable.

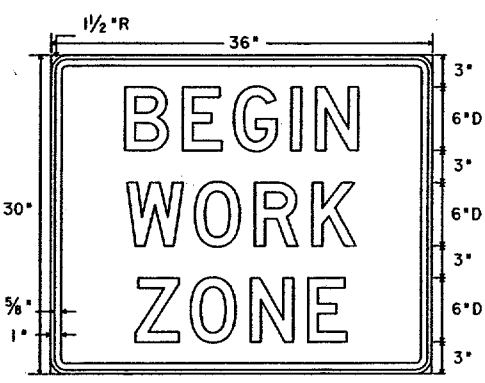

EG20-9T
 36" X 30"
 Letters - Black
 Border - Black
 Background - Orange Refl.

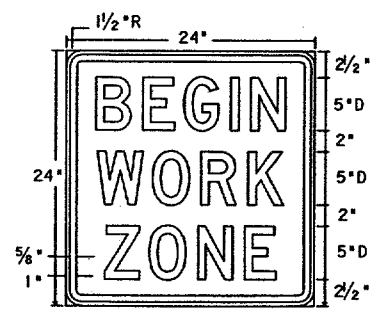

G20-9T
 24" X 24"
 Letters - Black
 Border - Black
 Background - Orange Refl.

LEVELS DISPLAYED
 1 2 3 4 5 6 7 8 9 10 11 12 13 14 15 16 17 18 19 20 21 22 23 24 25 26 27 28 29 30 31 32 33 34 35 36 37 38 39 40 41 42 43 44 45 46 47 48 49 50 51 52 53 54 55 56 57 58 59 60 61 62 63 64 65 66 67 68 69 70 71 72 73 74 75 76 77 78 79 80 81 82 83 84 85 86 87 88 89 90 91 92 93 94 95 96 97 98 99 100

STANDARD PLANS
 Texas Department of Transportation
 Traffic Operations Division

BARRICADE AND CONSTRUCTION REGULATORY & GUIDE SIGNS STANDARDS

12 of 12 BC(12)-03

REVISED	DATE	BY	DESCRIPTION
10-99	DAL	6	CM XXXX (XXX)
11-02			

COUNTY	CORNER	SECTION	JOB	ISSUE
DALLAS	****	**	***	VA

© TxDOT February 1998 GRB BAS FDN CAL