

01 GATE DETAIL
SC: 1/4"=1'-0"

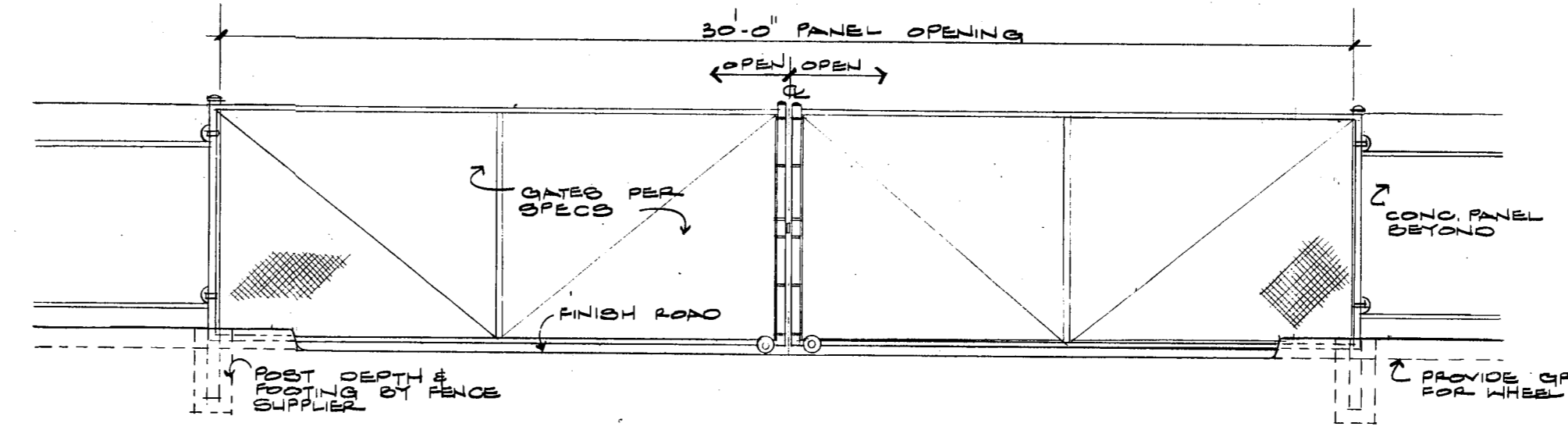

02 GATE DETAIL - INTERIOR VIEW
SC: 1/4"=1'-0"

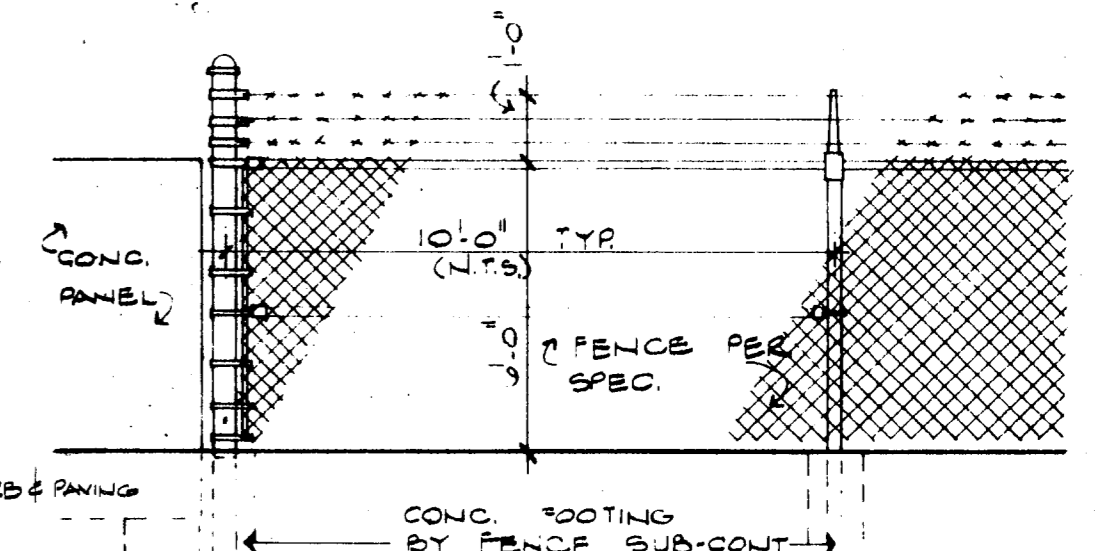

03 FENCE DETAIL
SC: 1/4"=1'-0"

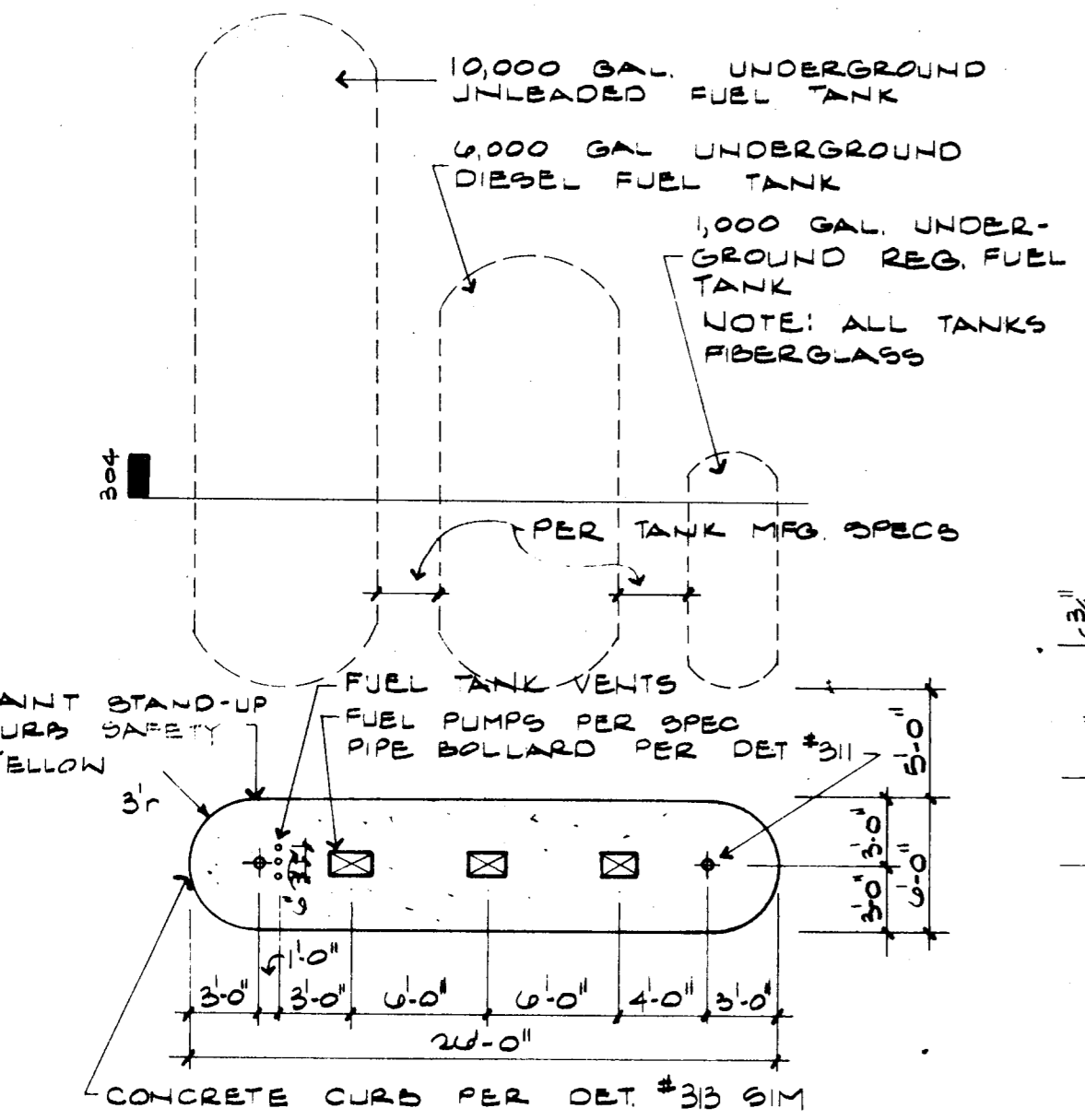

04 TANK SECTION
SC: 1/8"=1'-0"

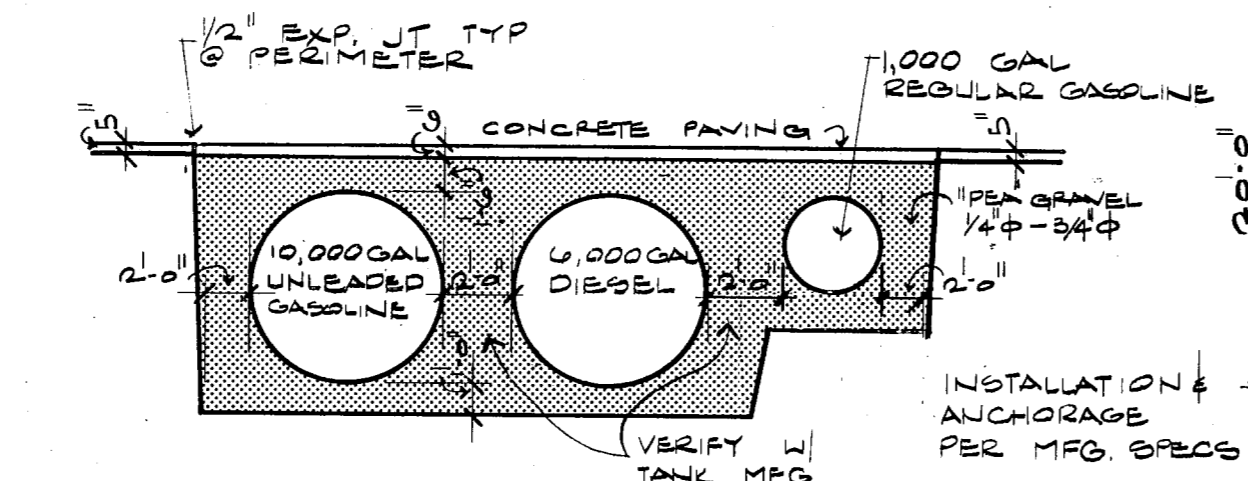

05 STORAGE AREA PLAN
SC: 1/8"=1'-0"

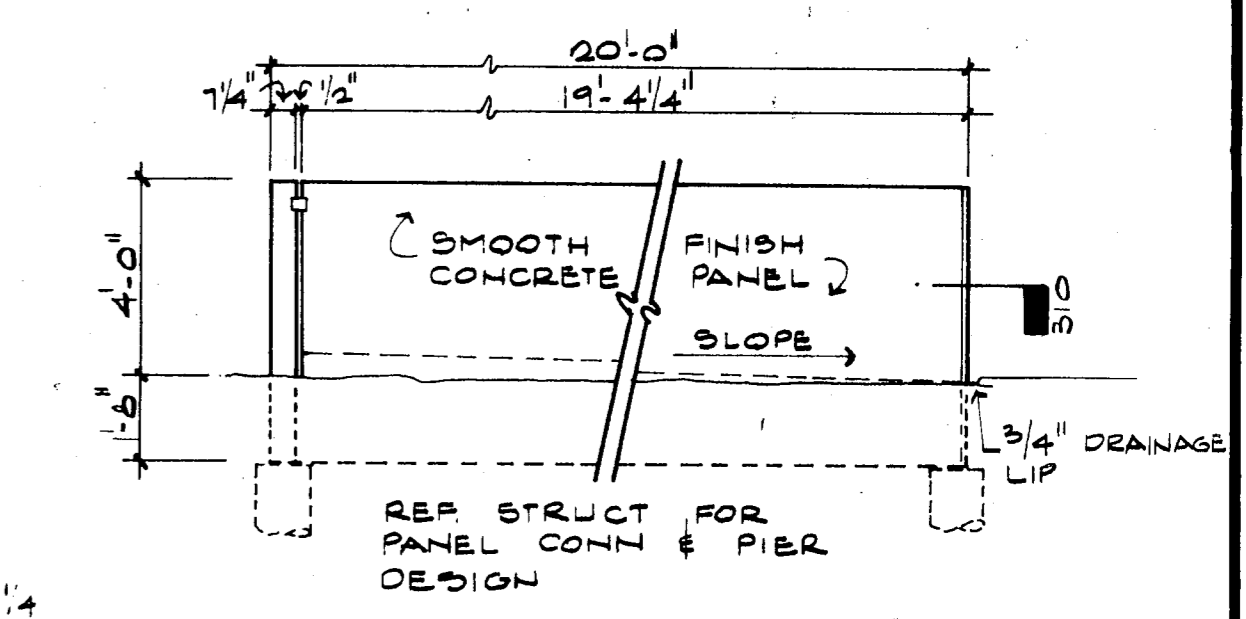

06 STORAGE AREA ELEVATION
SC: 1/4"=1'-0"

07 GAS ISLAND PLAN
SC: 1/4"=1'-0"

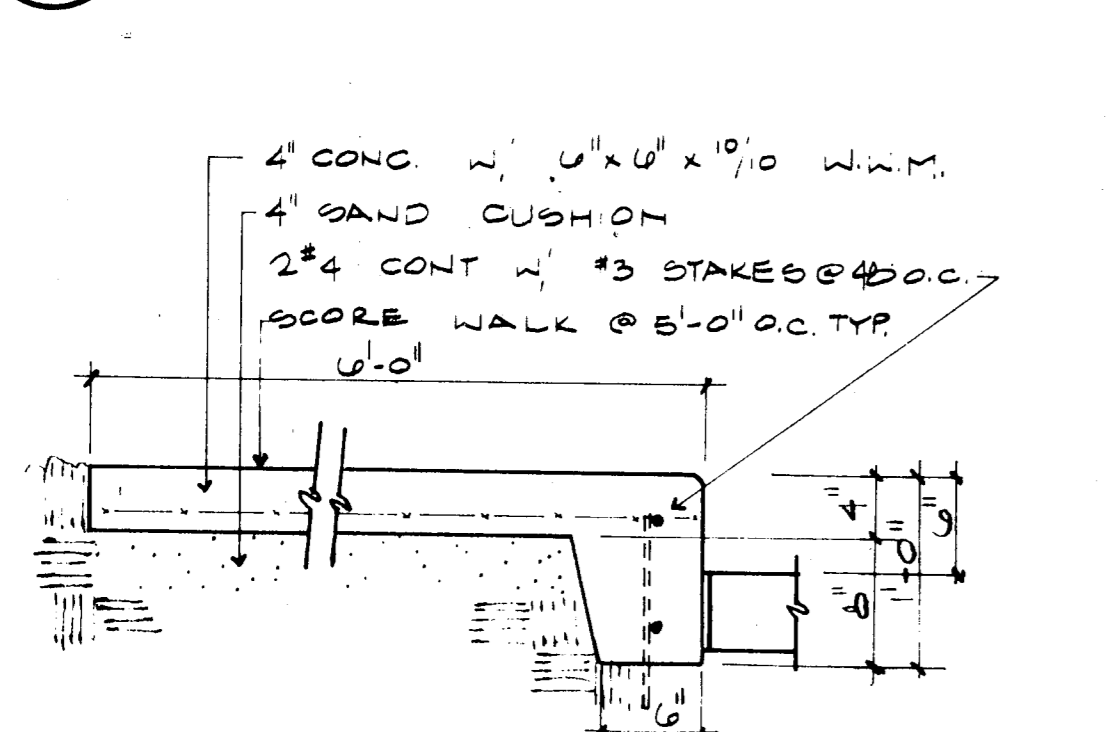

08 FILLER CAP DETAIL
SC: 1/2"=1'-0"

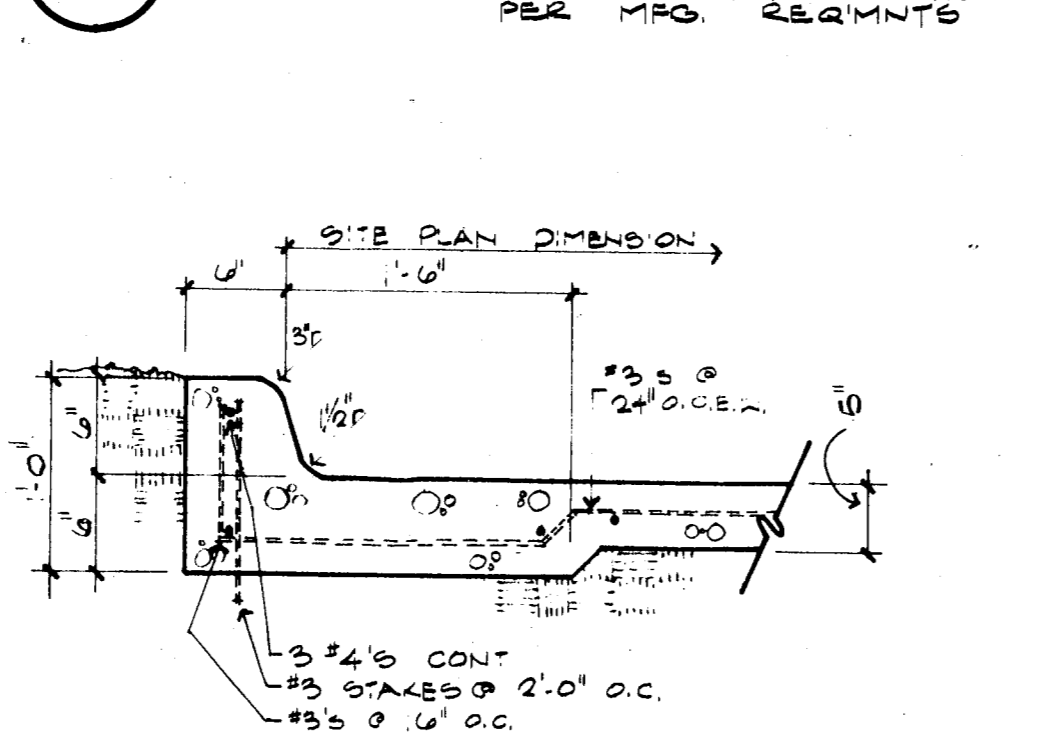

09 CONC. PANEL DETAIL
SC: 1/4"=1'-0"

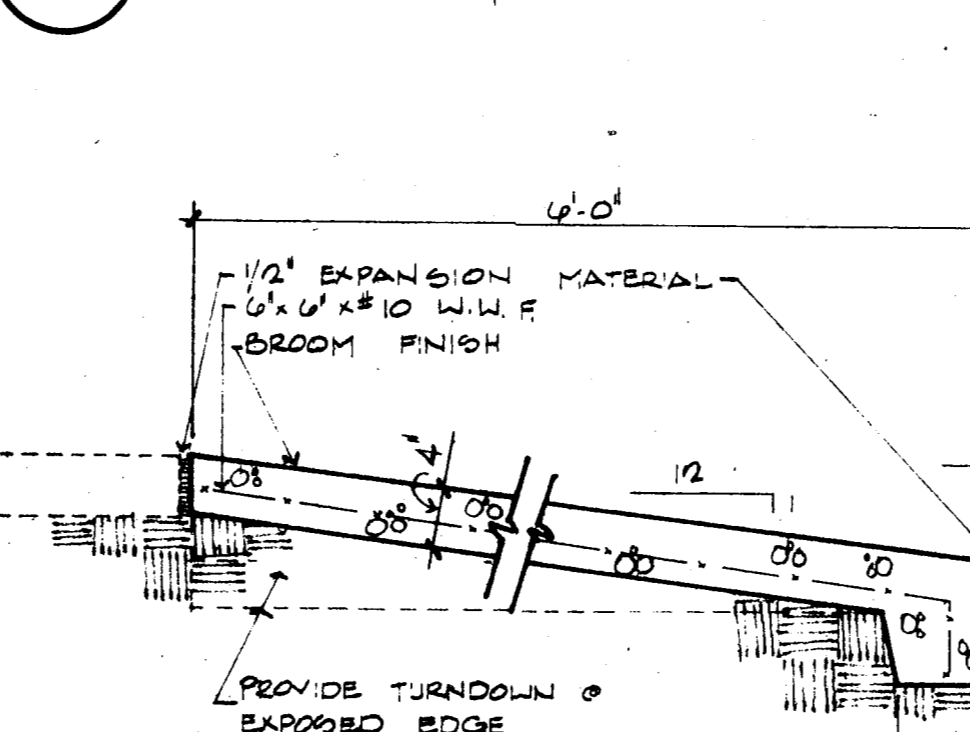

10 PANEL END DETAIL
SC: 1/2"=1'-0"

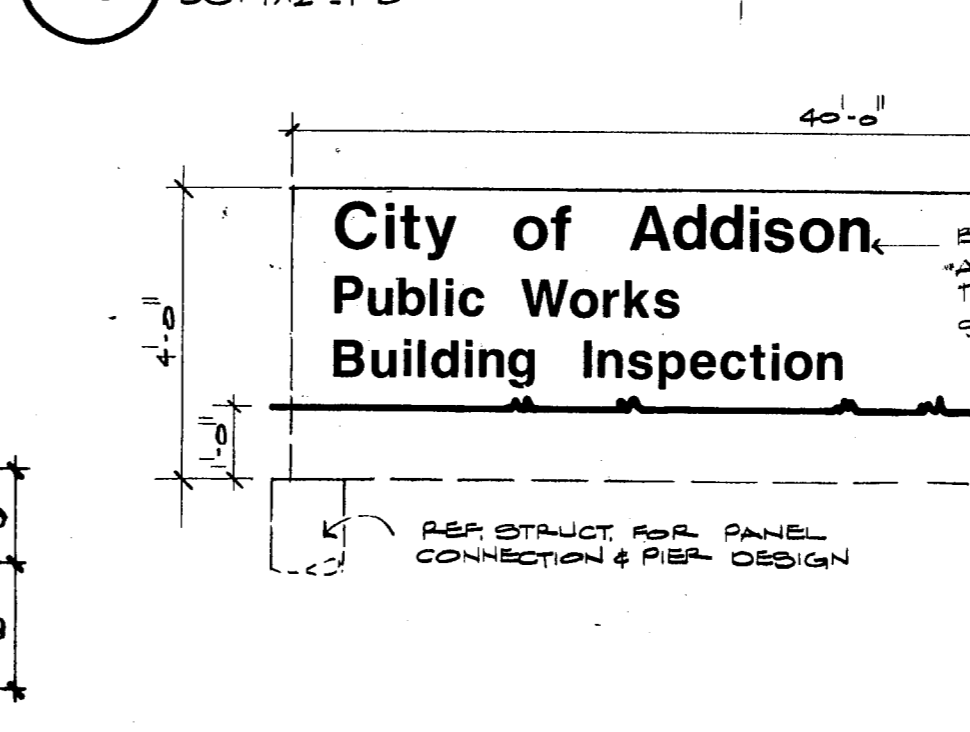

11 BOLLARD DETAIL
SC: 1/4"=1'-0"

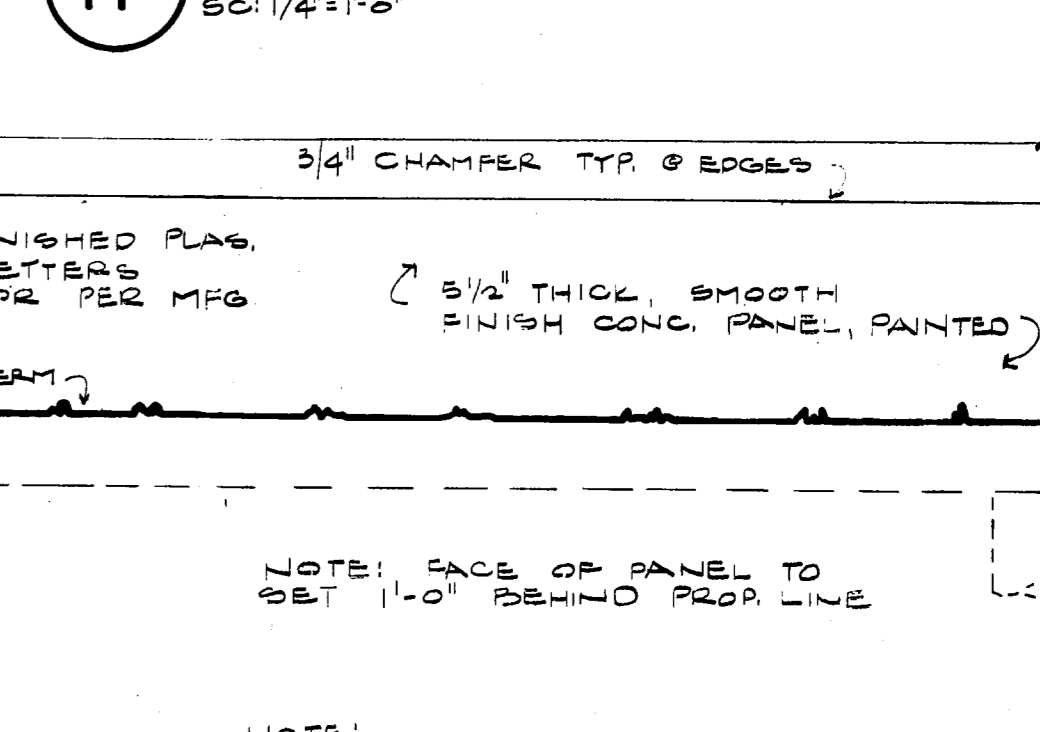

12 CONC. WALK
SC: 1"=1'-0"

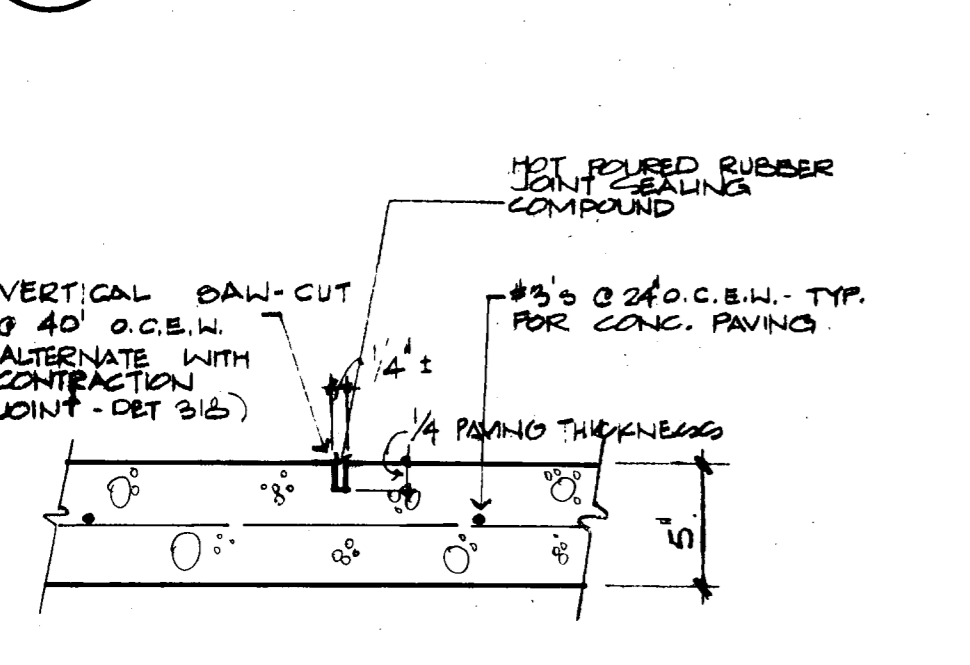

13 CONC. CURB
SC: 1"=1'-0"

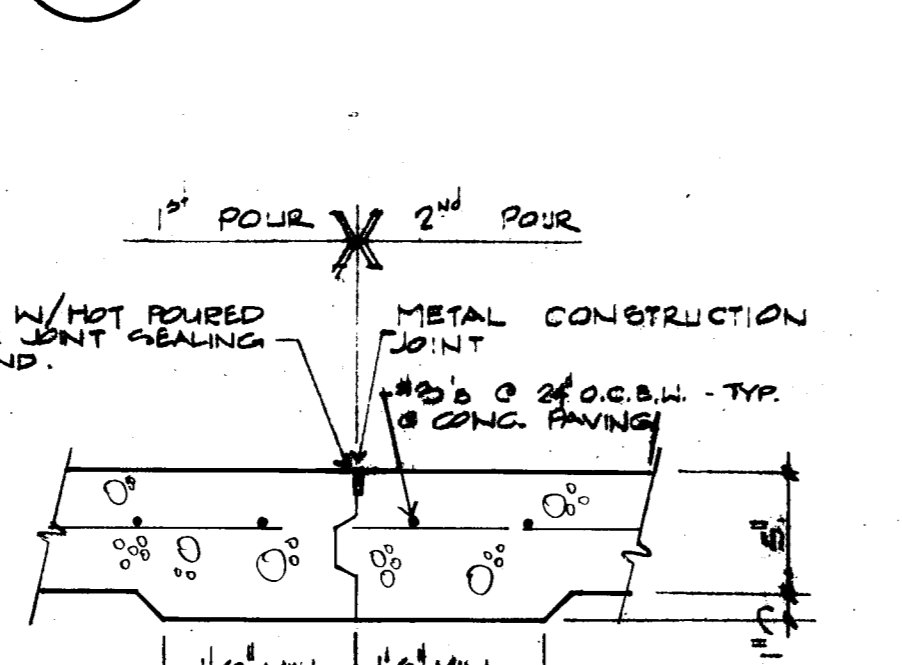

14 HANDICAP RAMP
SC: 1"=1'-0"

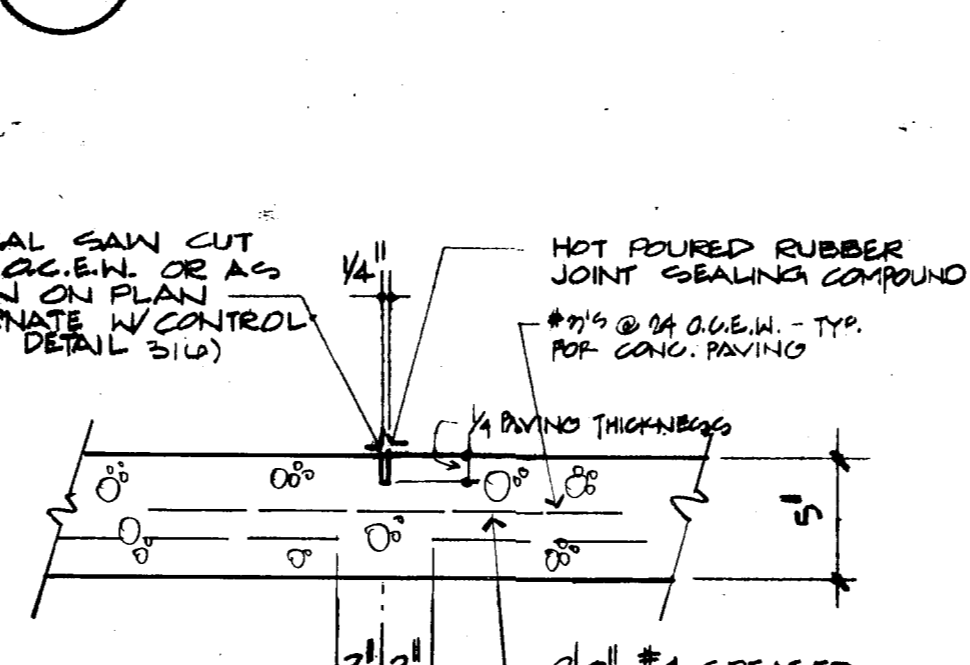

15 SCREENING WALL
SC: 3/8"=1'-0"

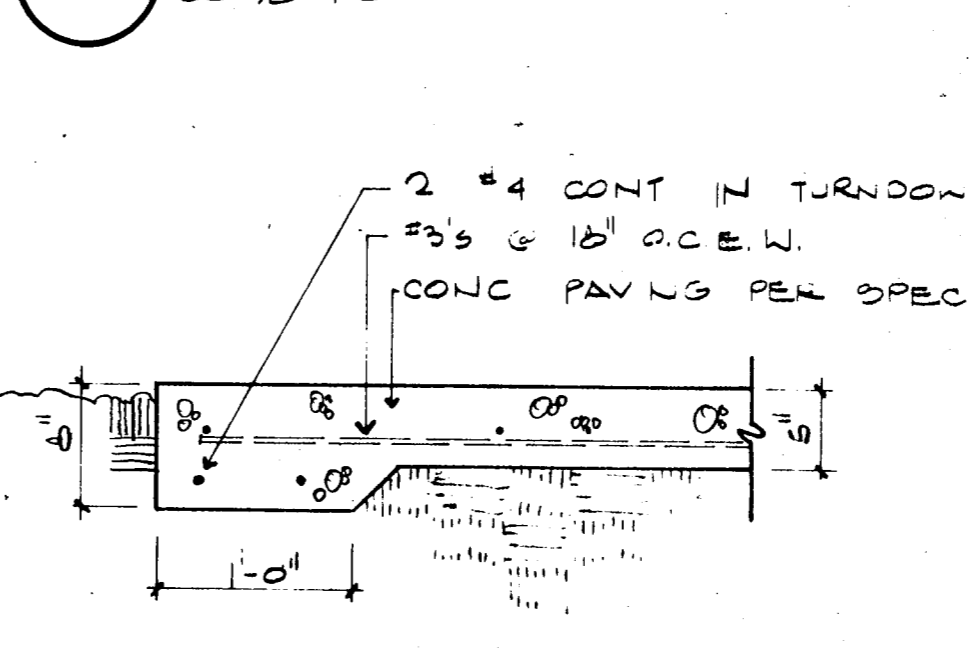

16 CONTROL JOINT
SC: 1/2"=1'-0"



17 CONSTRUCTION JOINT
SC: 1/2"=1'-0"

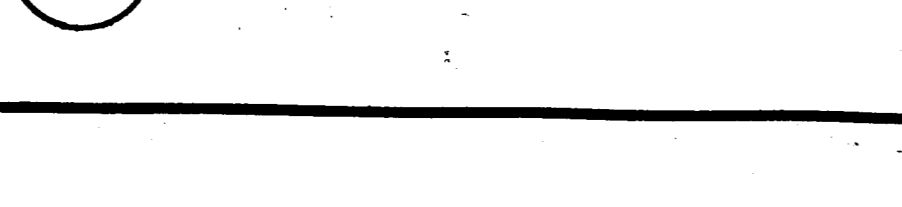

18 CONTRACTION JOINT
SC: 1/2"=1'-0"

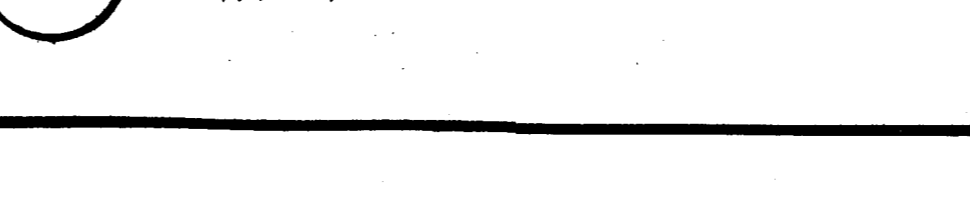

19 PAVING STOP
SC: 1"=1'-0"

